

# Becoming an “Atomic Architect”

From Cal to Google to LBL

*Tess Smidt*

*Berkeley Lab Computing Sciences*

*Computational Materials, Chemistry, and Climate Group*

*2018.10.23*

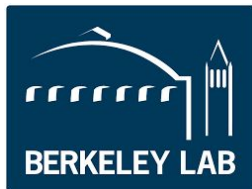

Research at Google

# Becoming an “Atomic Architect”

From Cal to Google to LBL

Overview of my research in deep learning

How did I get here?

My PhD in a nutshell

Intern at Google for 1 year

Choosing between Google and LBL

Q&A -- Ask me anything!

*Tess Smidt*

*Berkeley Lab Computing Sciences*

*Computational Materials, Chemistry, and Climate Group*

*2018.10.23*

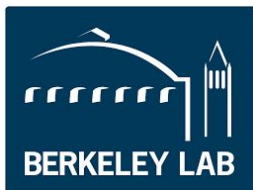

Research at Google

## What a computational materials physicist does:

Given an atomic structure,

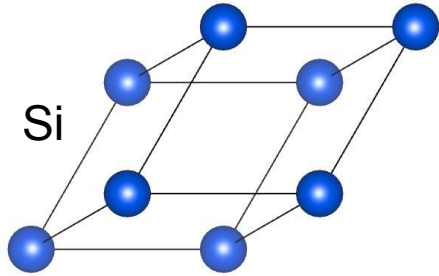

## What a computational materials physicist does:

...use quantum theory and  
supercomputers to  
determine...

Given an atomic structure,

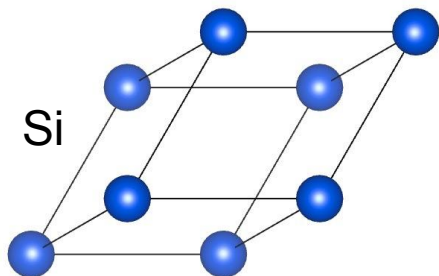

$$\hat{H} |\psi\rangle = E |\psi\rangle$$



National Energy Research  
Scientific Computing Center

## What a computational materials physicist does:

...use quantum theory and supercomputers to determine...

$$\hat{H} |\psi\rangle = E |\psi\rangle$$

Given an atomic structure,

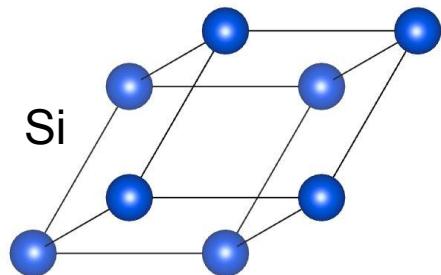

...where the electrons are...

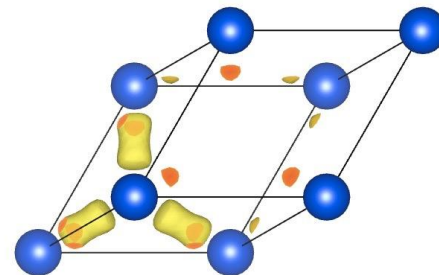

National Energy Research  
Scientific Computing Center

# What a computational materials physicist does:

...use quantum theory and supercomputers to determine...

$$\hat{H} |\psi\rangle = E |\psi\rangle$$



National Energy Research  
Scientific Computing Center

...where the electrons are...

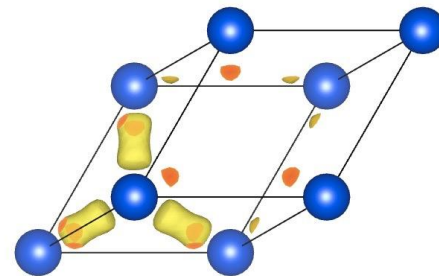

...and what the electrons are doing.

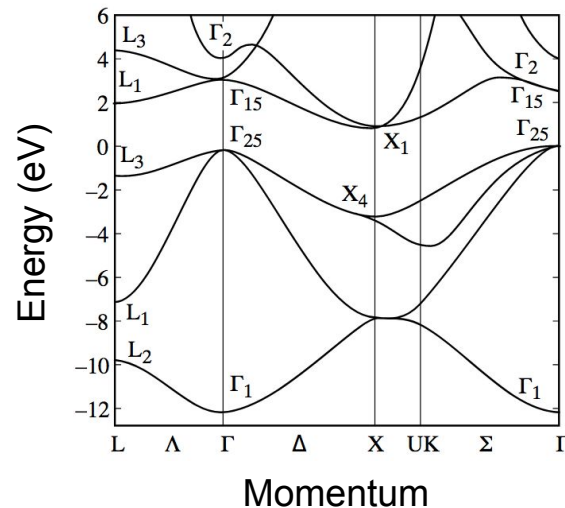

**Workflows are automated recipes that encode best practices for calculating materials properties. We use them to screen materials for specific properties and applications.**

**Workflows are automated recipes that encode best practices for calculating materials properties. We use them to screen materials for specific properties and applications.**

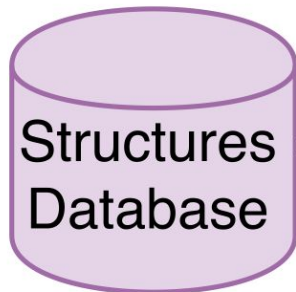



**Workflows are automated recipes that encode best practices for calculating materials properties. We use them to screen materials for specific properties and applications.**

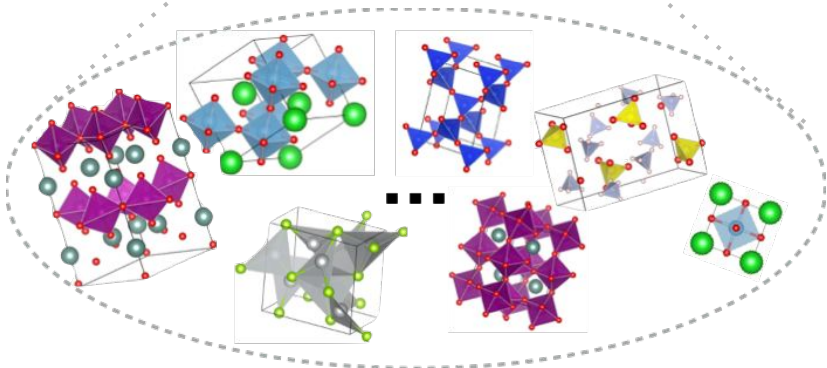
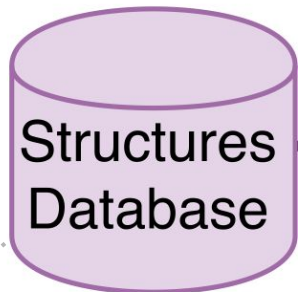

tens of thousands of structures

**Workflows are automated recipes that encode best practices for calculating materials properties. We use them to screen materials for specific properties and applications.**

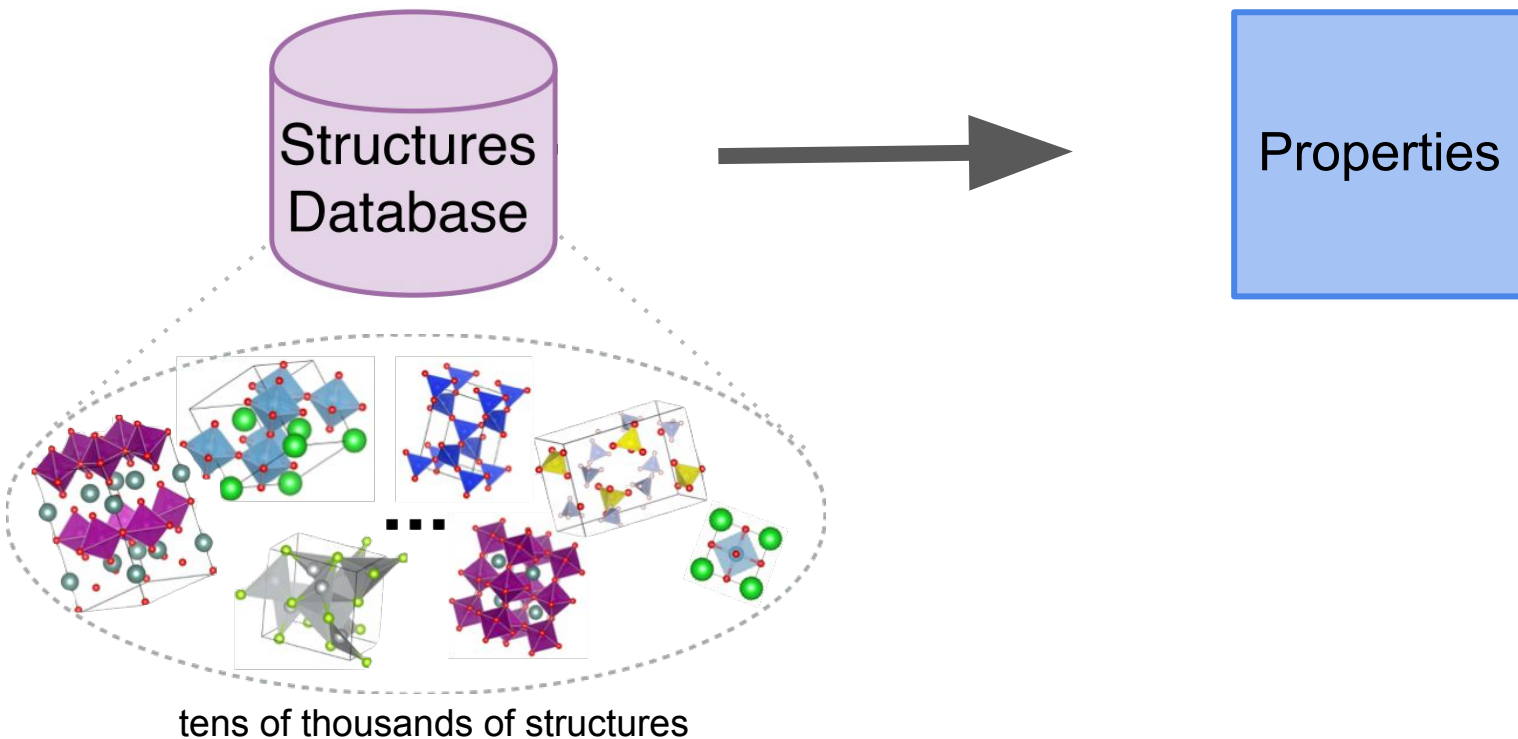

**Workflows are automated recipes that encode best practices for calculating materials properties. We use them to screen materials for specific properties and applications.**

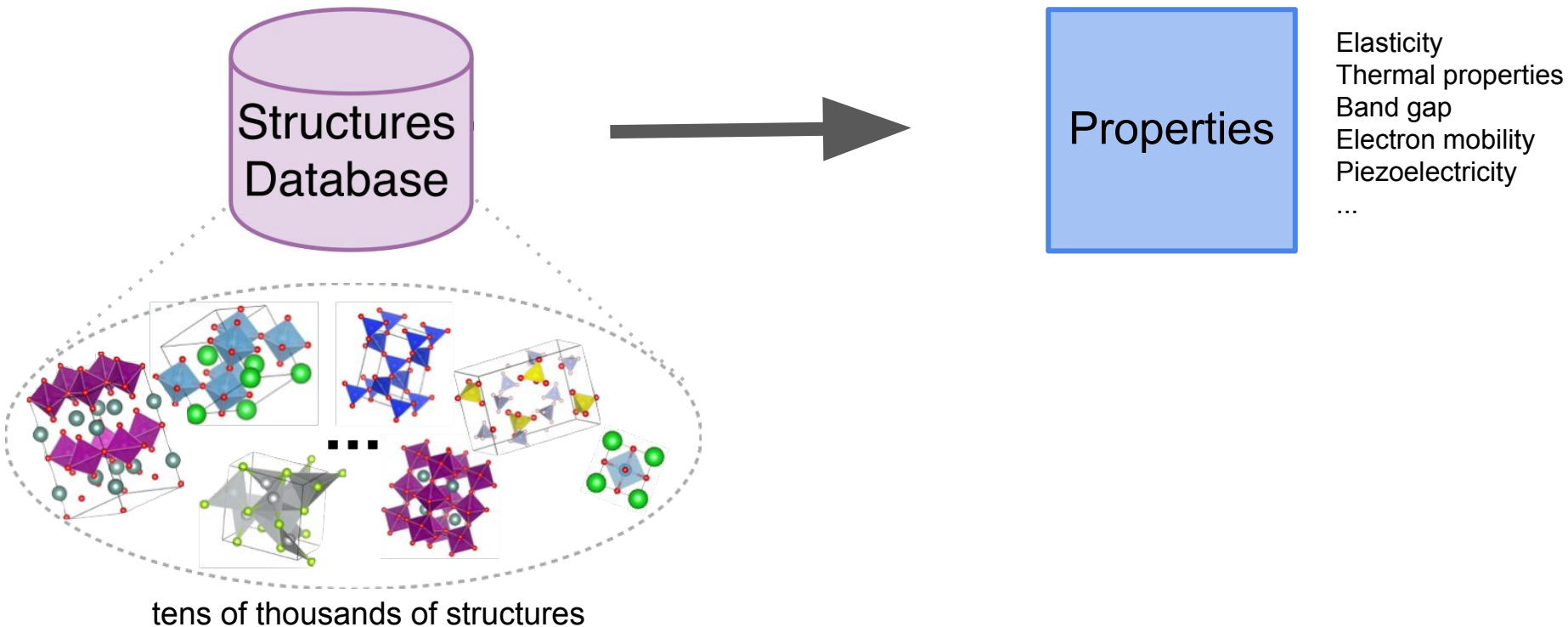

**Workflows are automated recipes that encode best practices for calculating materials properties. We use them to screen materials for specific properties and applications.**

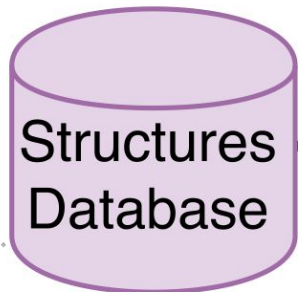

Elasticity  
Thermal properties  
Band gap  
Electron mobility  
Piezoelectricity  
...

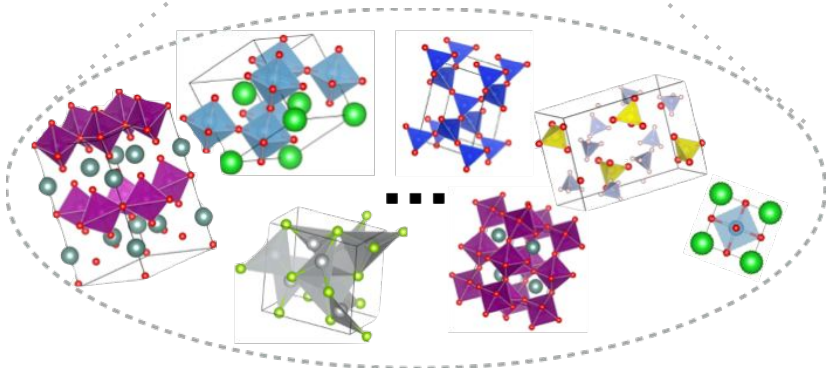

tens of thousands of structures

Photovoltaics

Batteries

Magnetic materials

Water-splitting catalysts

**However, screening is bottlenecked limited by our ability to propose hypothetical atomic structures.**

**However, screening is bottlenecked limited by our ability to propose hypothetical atomic structures.**

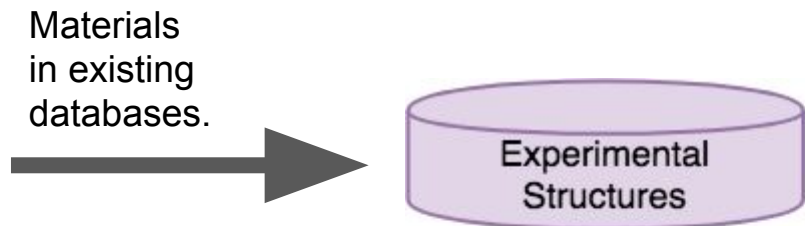

**However, screening is bottlenecked limited by our ability to propose hypothetical atomic structures.**

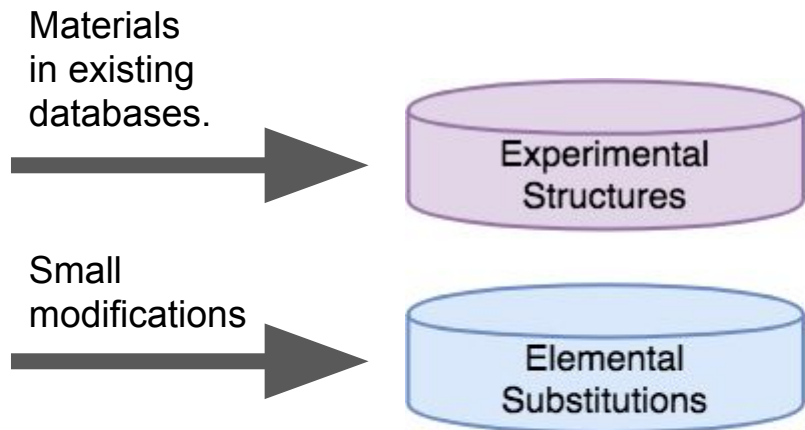

However, screening is bottlenecked limited by our ability to propose hypothetical atomic structures.

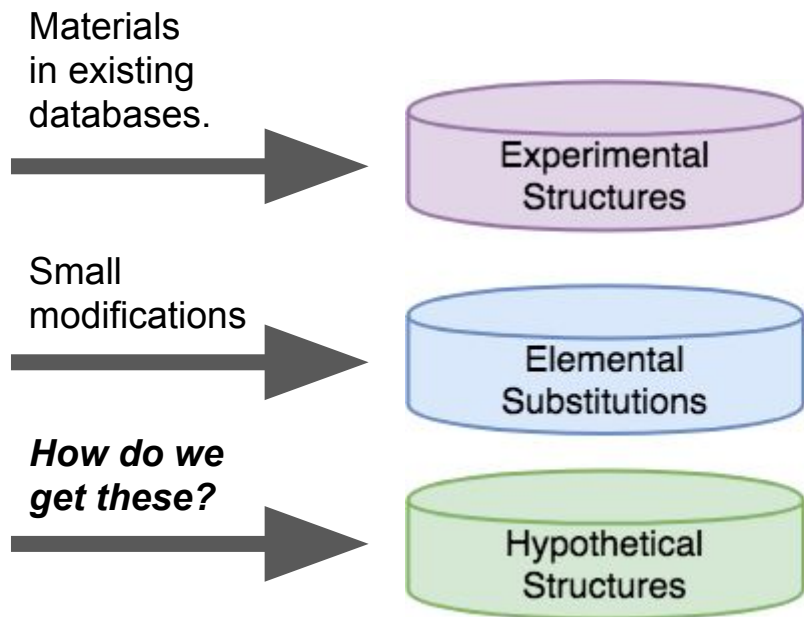



However, screening is bottlenecked limited by our ability to propose hypothetical atomic structures.

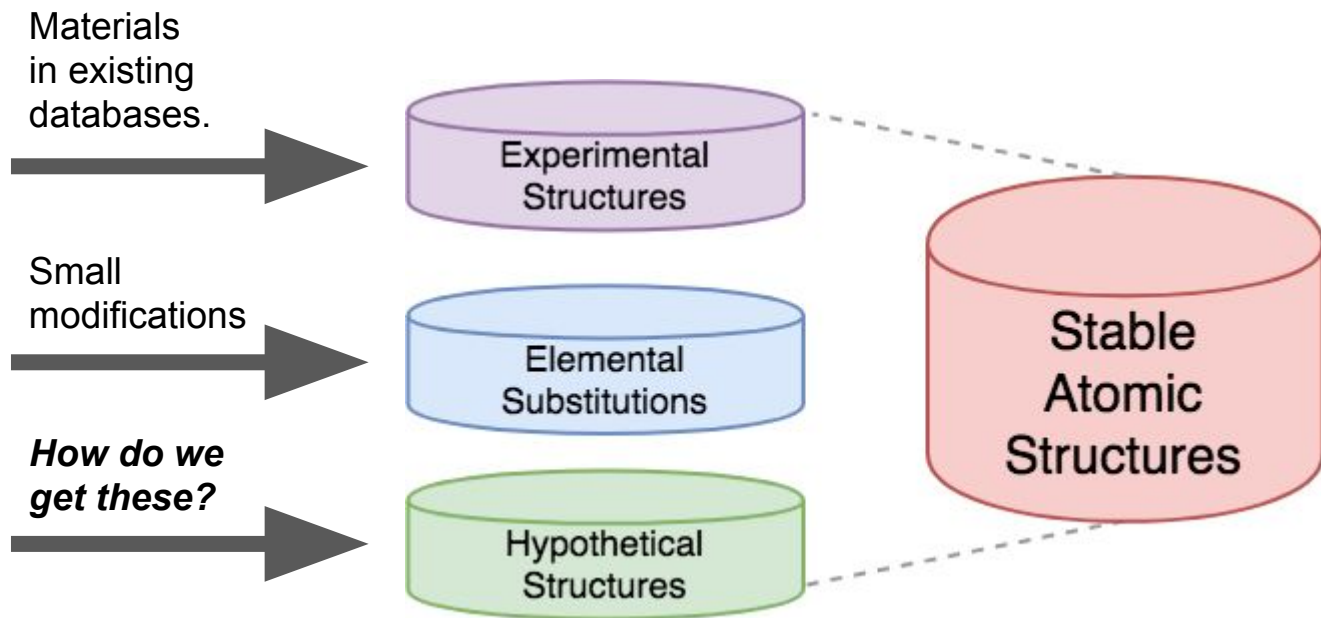

Experimentalists are making new structures every day! These structures are not in existing databases.

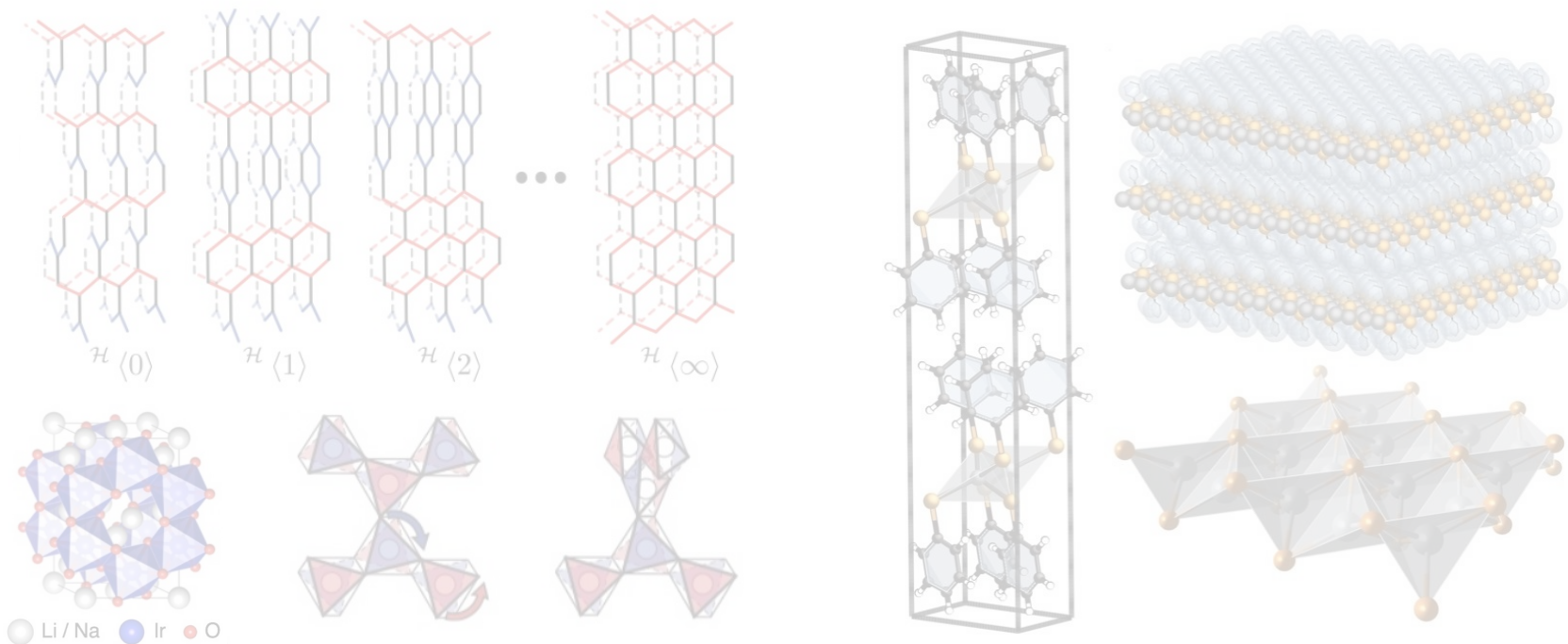

T. Smidt, S. Griffin, and J. B. Neaton, *Ab initio Studies of Structural and Energetic Trends in the Harmonic Honeycomb Iridates*, In preparation for submission to Physical Review: B (2018).

K. Modic, T. Smidt, I. Kimchi et al., *Realization of a three-dimensional spin-anisotropic harmonic honeycomb iridate*, Nature Communications 5 (2014). (arXiv:1402.3254)

J.N. Hohman, M. Collins, and T. Smidt, *Mithrene and methods of fabrication of mithrene*, (2017). International Patent App. PCT/US2017/045609. Filed August 4, 2017.

Experimentalists are making new structures every day! These structures are not in existing databases.

Harmonic honeycomb iridates:  
Frustrated quantum magnets

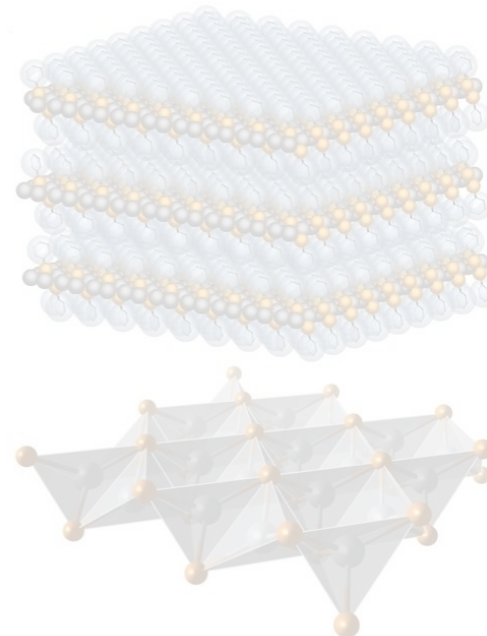
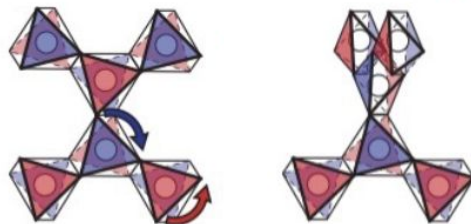
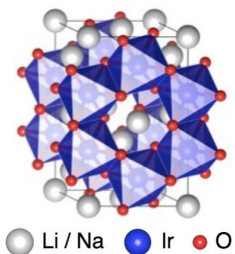
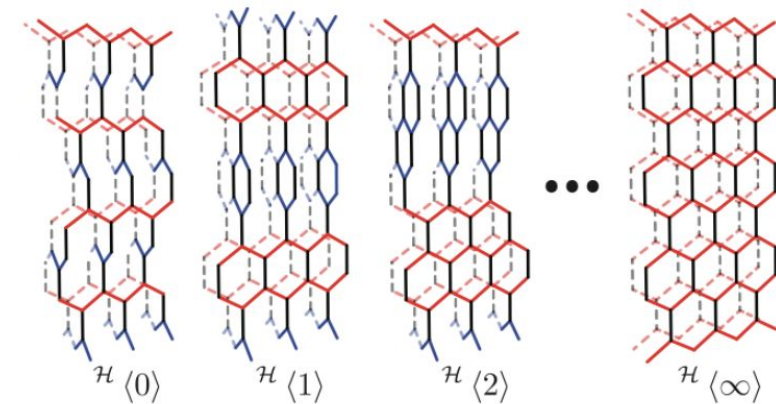

T. Smidt, S. Griffin, and J. B. Neaton, *Ab initio Studies of Structural and Energetic Trends in the Harmonic Honeycomb Iridates*, In preparation for submission to Physical Review: B (2018).

K. Modic, T. Smidt, I. Kimchi et al., *Realization of a three-dimensional spin-anisotropic harmonic honeycomb iridate*, Nature Communications 5 (2014). (arXiv:1402.3254)

J.N. Hohman, M. Collins, and T. Smidt, *Mithrene and methods of fabrication of mithrene*, (2017). International Patent App. PCT/US2017/045609. Filed August 4, 2017.

Experimentalists are making new structures every day! These structures are not in existing databases.

Harmonic honeycomb iridates:  
Frustrated quantum magnets

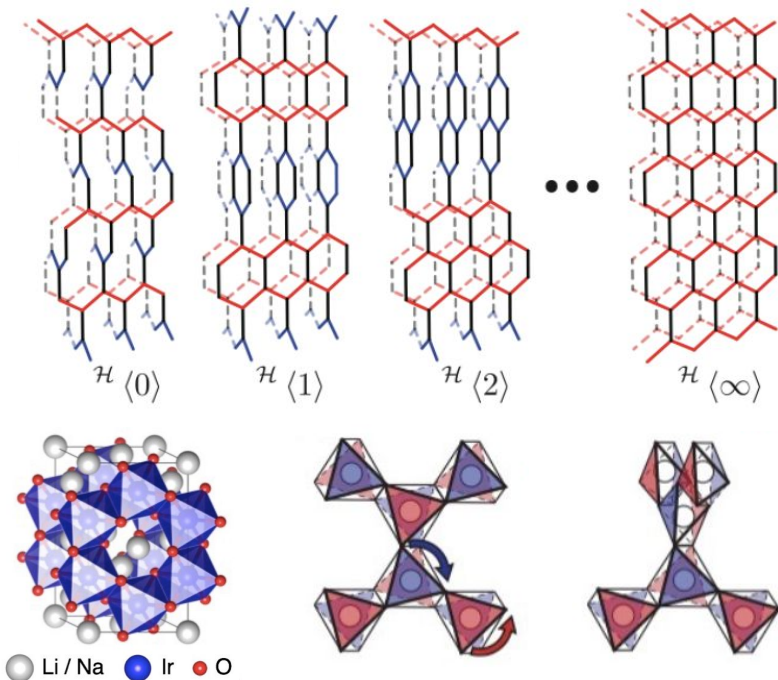

Metal-organic chalcogenide assemblies (MOChAs):  
2D electronic properties in a 3D crystal

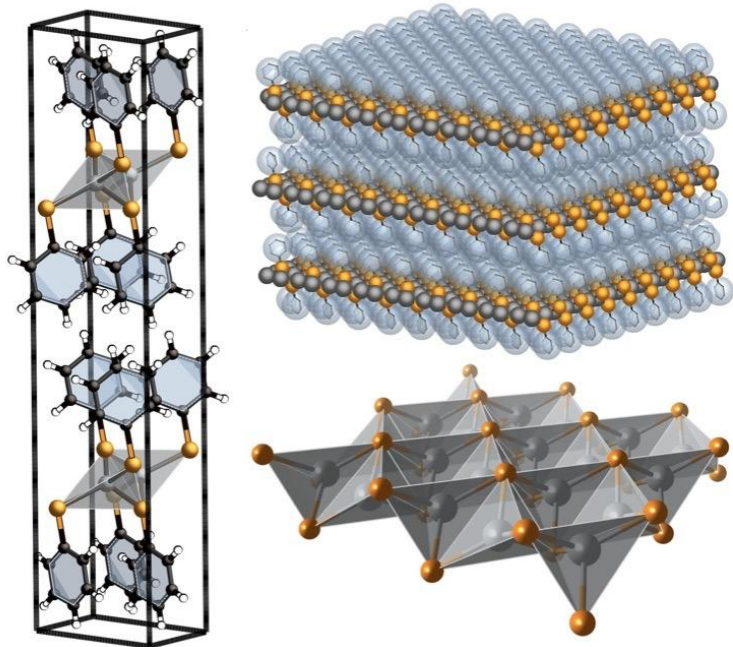

T. Smidt, S. Griffin, and J. B. Neaton, *Ab initio Studies of Structural and Energetic Trends in the Harmonic Honeycomb Iridates*, In preparation for submission to Physical Review: B (2018).

K. Modic, T. Smidt, I. Kimchi et al., *Realization of a three-dimensional spin-anisotropic harmonic honeycomb iridate*, Nature Communications 5 (2014). (arXiv:1402.3254)

J.N. Hohman, M. Collins, and T. Smidt, *Mithrene and methods of fabrication of mithrene*, (2017). International Patent App. PCT/US2017/045609. Filed August 4, 2017.

Materials are challenging to design because their 3D geometry and interactions are complex.

*Ex: Hypothetical materials that I designed by hand (with parametric models).*

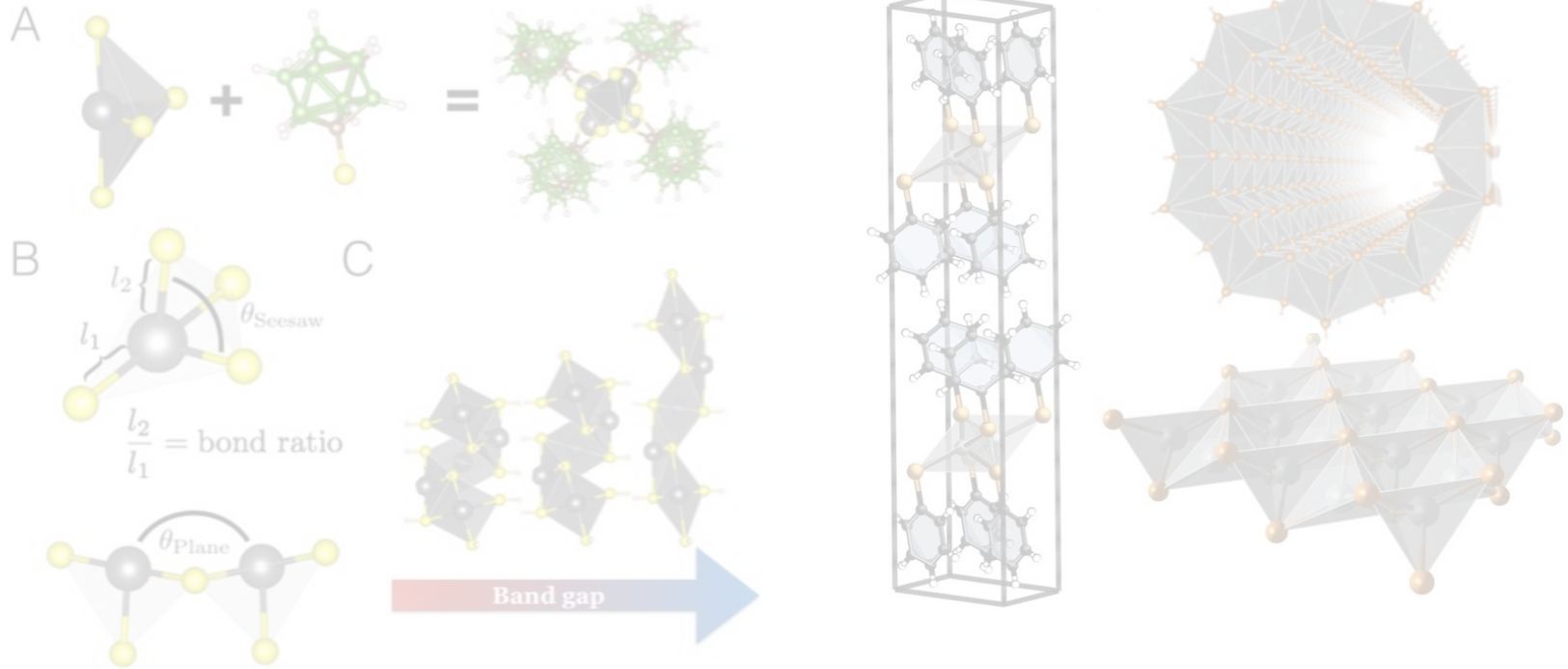



Materials are challenging to design because their 3D geometry and interactions are complex.

*Ex: Hypothetical materials that I designed by hand (with parametric models).*

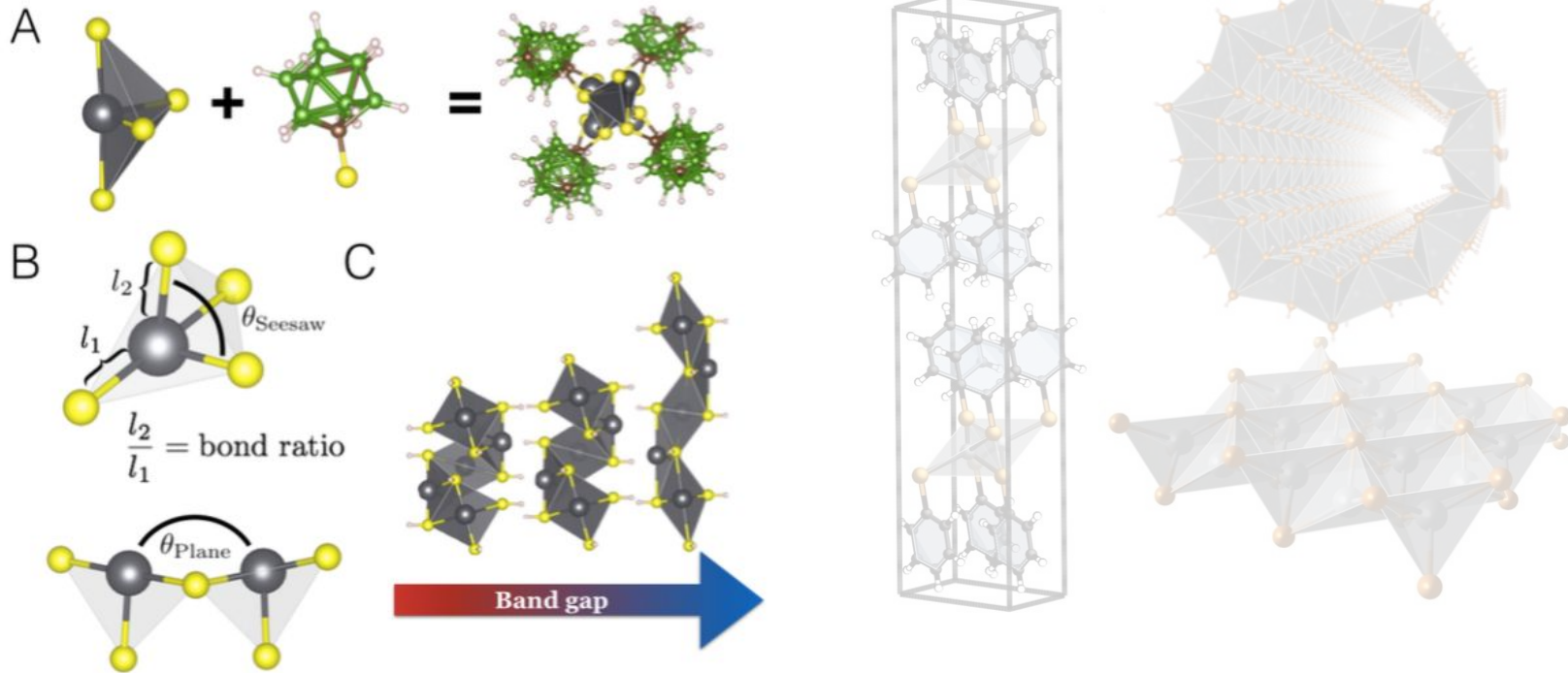

Distort subunits to tune properties.

Materials are challenging to design because their 3D geometry and interactions are complex.

*Ex: Hypothetical materials that I designed by hand (with parametric models).*

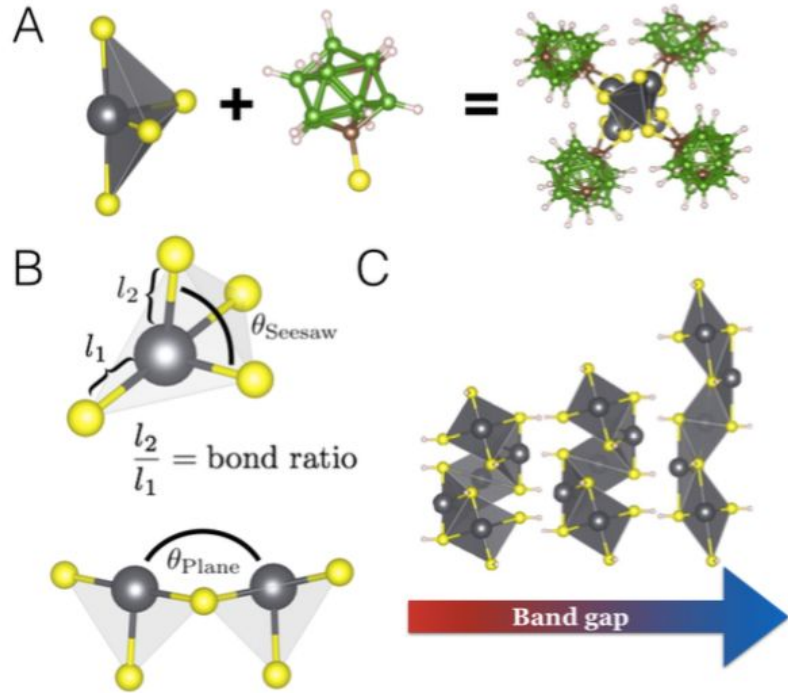

Distort subunits to tune properties.

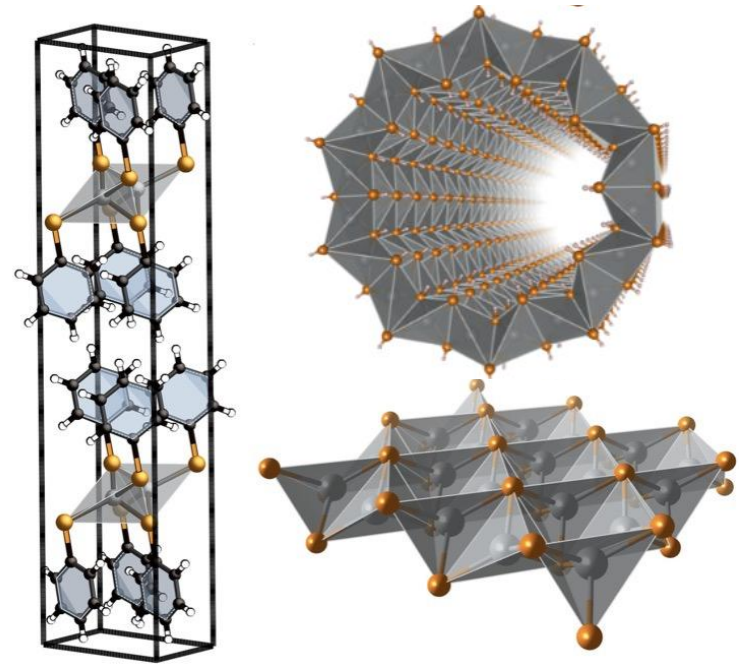

Produce new topologies that are chemically viable.

Materials are challenging to design because their 3D geometry and interactions are complex.

*Ex: Hypothetical materials that I designed by hand (with parametric models).*

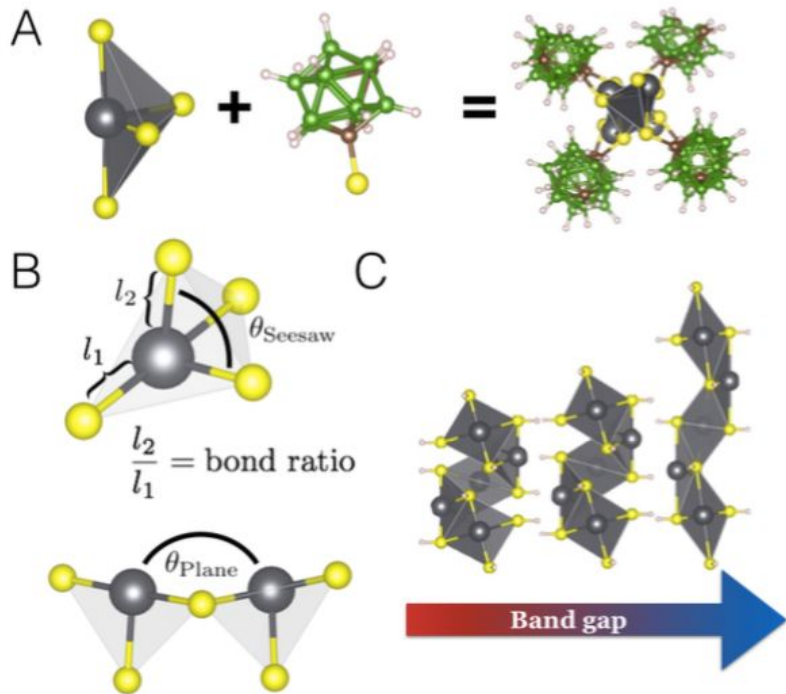

Distort subunits to tune properties.

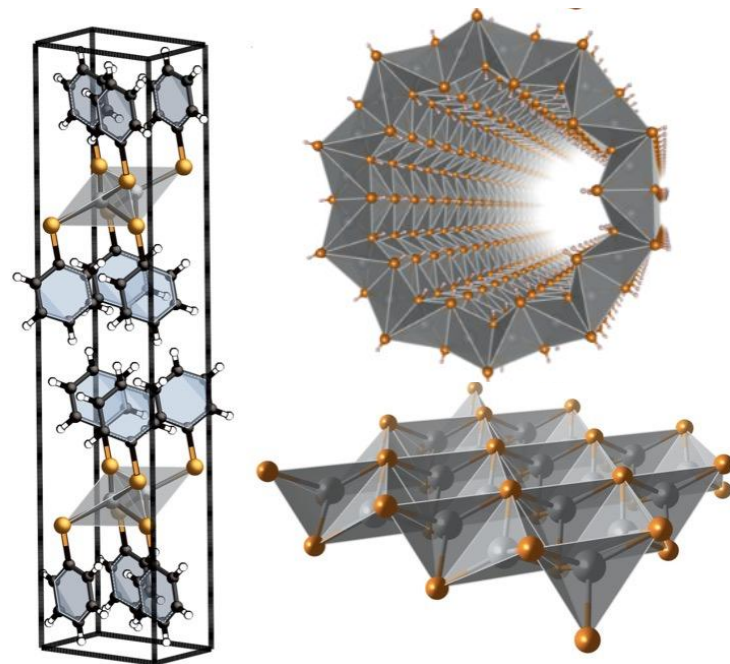

Produce new topologies that are chemically viable.

We need better tools to systematically generate new hypothetical atomic structures.



Deep learning can help accelerate existing tools and create new capabilities for automating computational chemical and materials discovery.

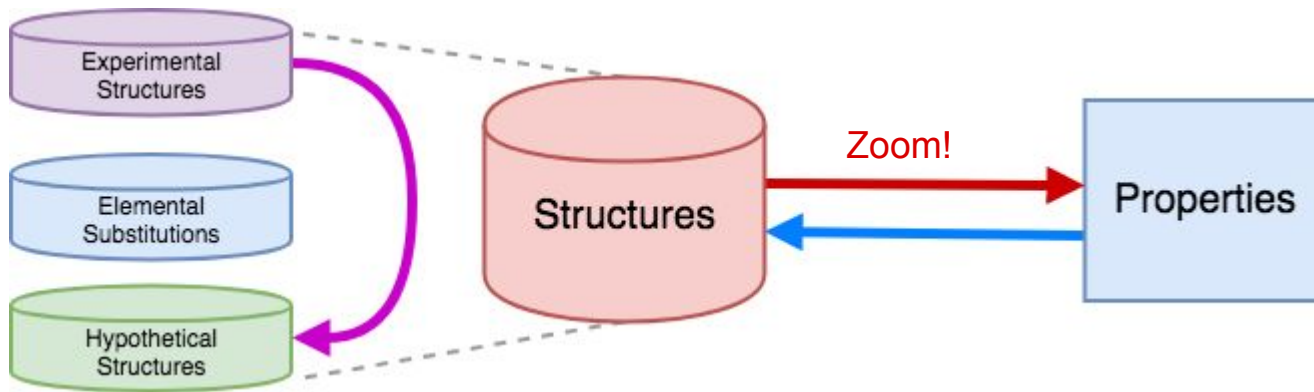

- 1) Help compute properties faster.
- 2) Generate hypothetical structures based on experimentally observed motifs.
- 3) Generate structures with specific properties. [Need to do (2) first.]

## Previous work

It is possible to train neural networks that can predict properties with the accuracy of quantum-mechanical calculations between 2 and 5 orders of magnitude faster.

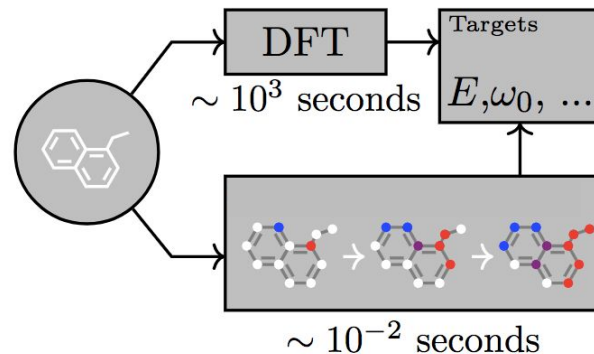

J. Gilmer, S. S. Schoenholz, P. F. Riley, O. Vinyals, and G. E. Dahl, "Neural Message Passing for Quantum Chemistry." arXiv preprint arXiv:1704.01212 (2017).

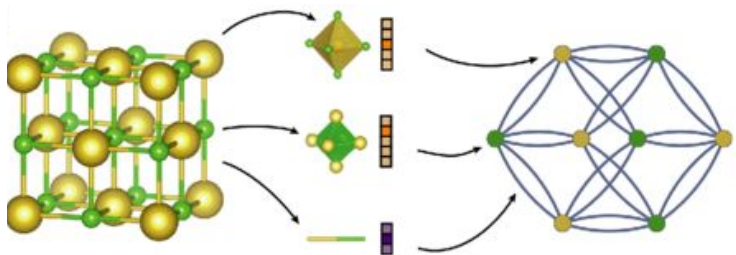

Tian Xie and Jeffrey C. Grossman. "Crystal Graph Convolutional Neural Networks for an Accurate and Interpretable Prediction of Material Properties", Phys. Rev. Lett. 120, 145301 (2018)

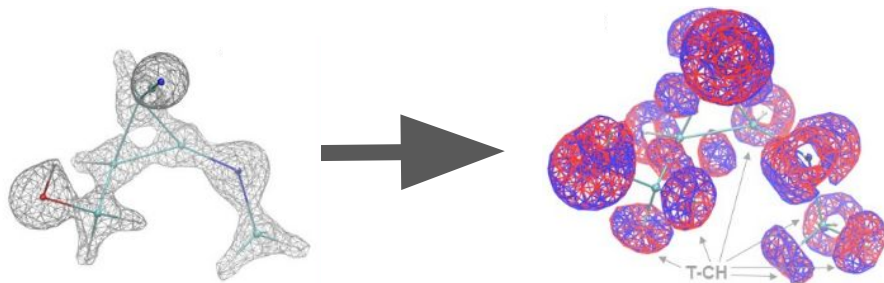

Anton V. Sitskiy, Vijay S. Pande, "Deep Neural Network Computes Electron Densities and Energies of a Large Set of Organic Molecules Faster than Density Functional Theory (DFT)", arXiv:1809.02723

## Previous work

Deep learning techniques have also been used to generate new molecules for applications such as drugs and devices.

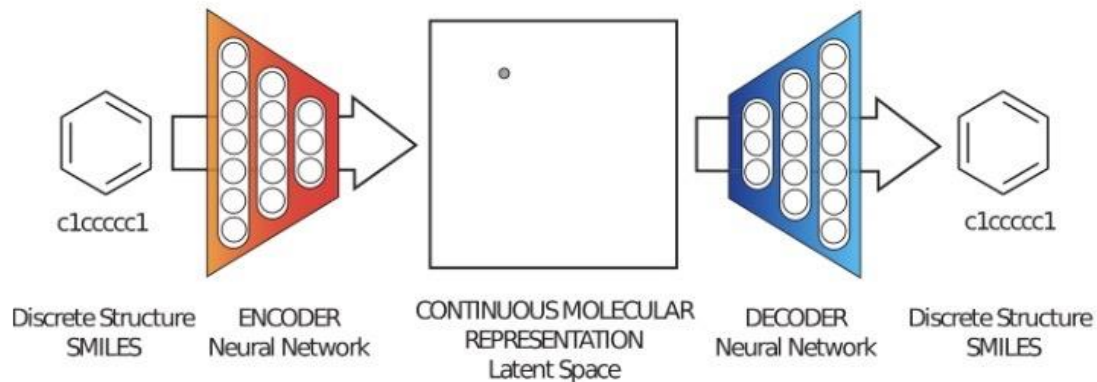

Properties can be optimized using learned continuous representation or reinforcement learning.

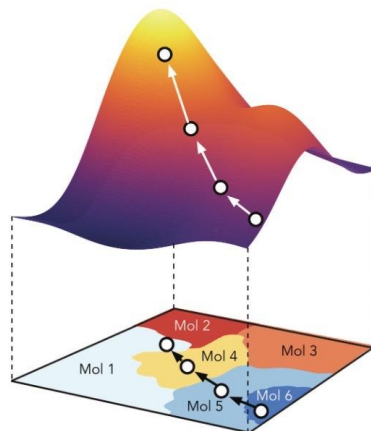

Gómez-Bombarelli, Rafael, et al. "Automatic chemical design using a data-driven continuous representation of molecules." ACS Cent. Sci., 4 (2), pp 268–276(2018)

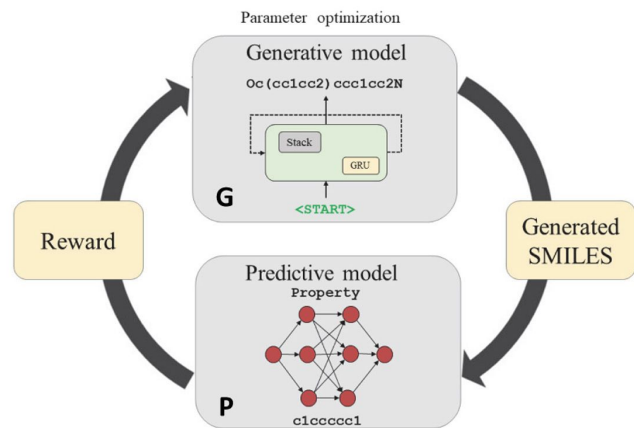

Mariya Popova, Olexandr Isayev, Alexander Tropsha, "Reinforcement learning for de novo drug design" Science Advances, Vol. 4, no. 7, eaap7885 (2018)

These examples used very different input representations. (strings, graphs, images)

How to represent atomic systems to neural networks is an open question.

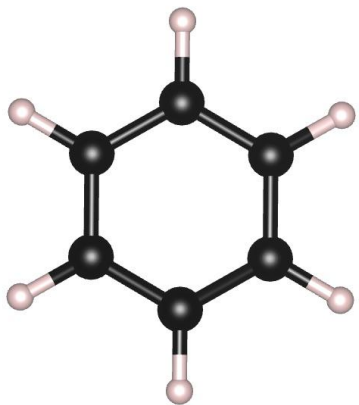

Many representations of  
benzene...

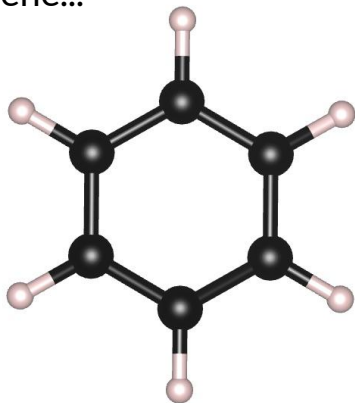

Many representations of benzene...

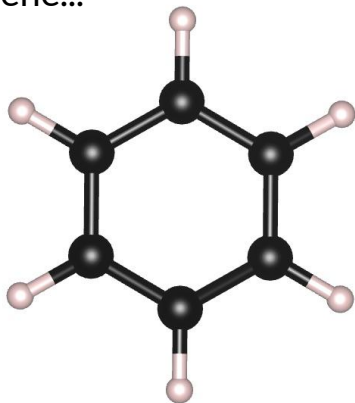

Vector (Fingerprint)



Many representations of benzene...

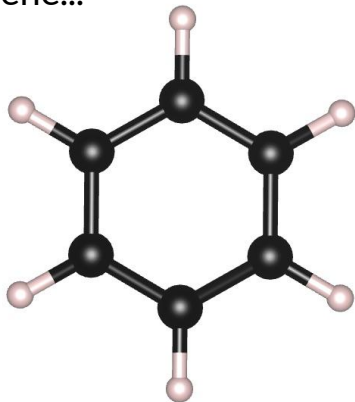

Vector (Fingerprint)



SMILES string:  
C1=CC=CC=C1



Many representations of benzene...

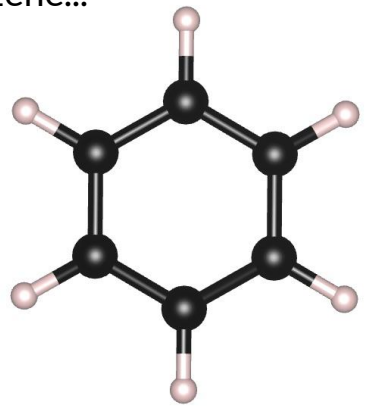

Vector (Fingerprint)



SMILES string:  
C1=CC=CC=C1

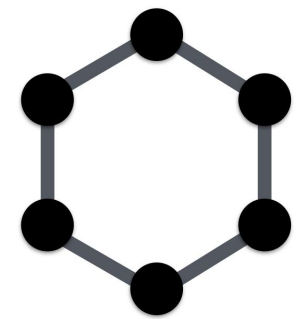

Graph of bonds

Many representations of benzene...

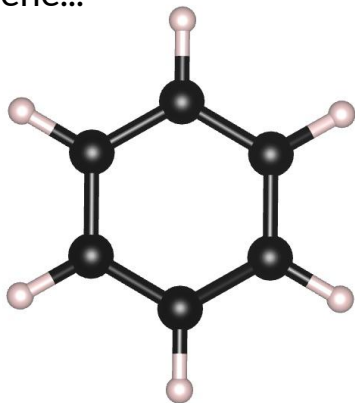

Vector (Fingerprint)



SMILES string:  
C1=CC=CC=C1

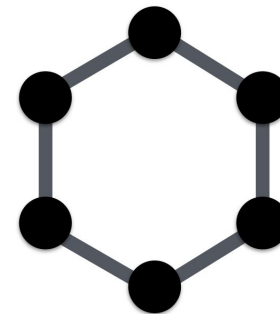

Graph of bonds

Image

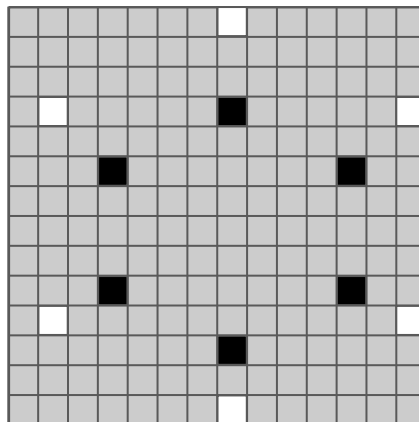

Many representations of benzene...

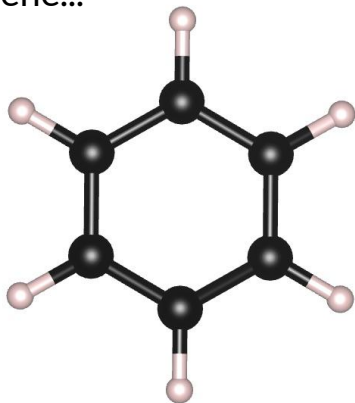

Vector (Fingerprint)



SMILES string:  
C1=CC=CC=C1

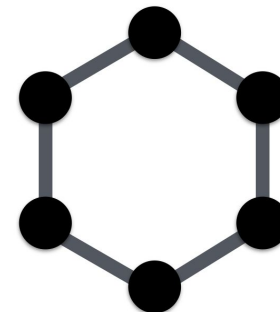

Graph of bonds

Image

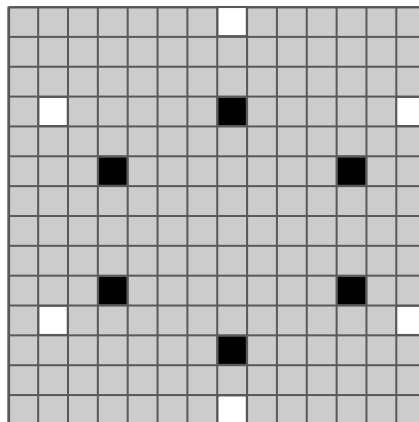

3D Coordinates

H	-0.21463	0.97837	0.33136
C	-0.38325	0.66317	-0.70334
C	-1.57552	0.03829	-1.05450
H	-2.34514	-0.13834	-0.29630
C	-1.78983	-0.36233	-2.36935
H	-2.72799	-0.85413	-2.64566
C	-0.81200	-0.13809	-3.33310
H	-0.98066	-0.45335	-4.36774
C	0.38026	0.48673	-2.98192
H	1.14976	0.66307	-3.74025
C	0.59460	0.88737	-1.66708
H	1.53276	1.37906	-1.39070

Many representations of benzene...

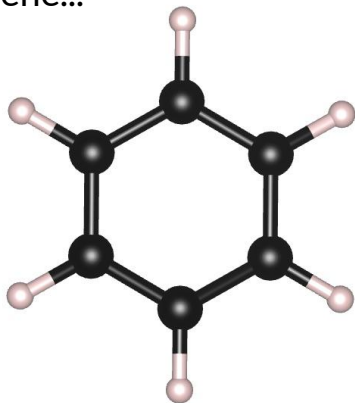

	Bonding	Geometry	Memory Efficient	Universality
Fingerprints	?	?	✓	?
SMILES	✓	X	✓	X
Graphs	✓	?	?	?
Images	X	✓	X	✓
Coordinates	X	✓	✓	✓

Many representations of benzene...

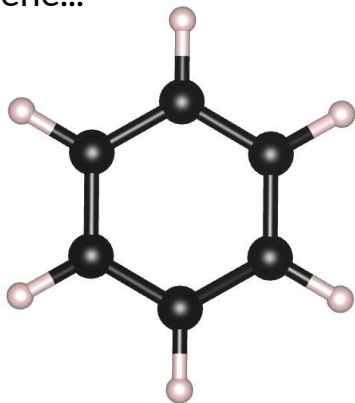

Vector (Fingerprint)



SMILES string:  
C1=CC=CC=C1

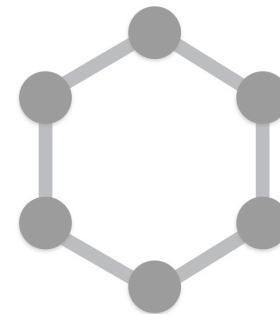

Graph of bonds

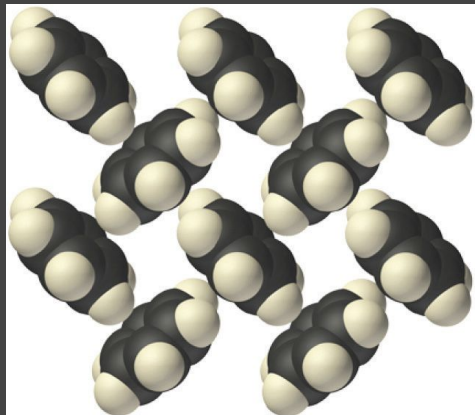

Image

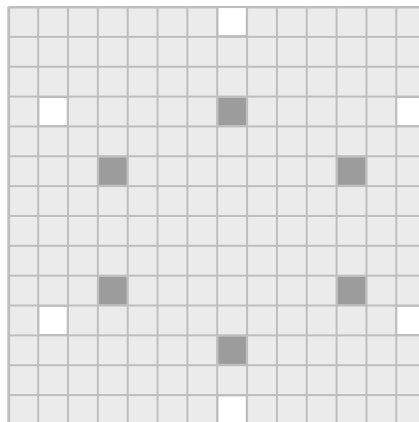

3D Coordinates

H	-0.21463	0.97837	0.33136
C	-0.38325	0.66317	-0.70334
C	-1.57552	0.03829	-1.05450
H	-2.34514	-0.13834	-0.29630
C	-1.78983	-0.36233	-2.36935
H	-2.72799	-0.85413	-2.64566
C	-0.81200	-0.13809	-3.33310
H	-0.98066	-0.45335	-4.36774
C	0.38026	0.48673	-2.98192
H	1.14976	0.66307	-3.74025
C	0.59460	0.88737	-1.66708
H	1.53276	1.37906	-1.39070

Many representations of benzene...

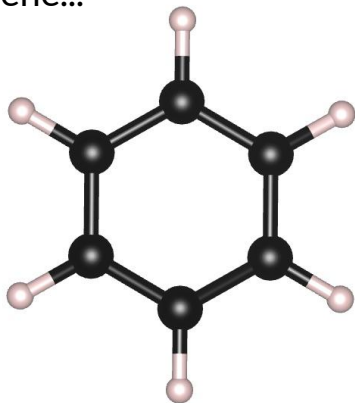

Vector (Fingerprint)



~~SMILES string:~~  
C1=CC=CC=C1

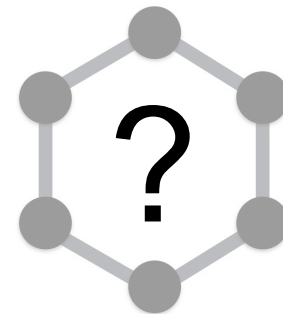

Graph of bonds

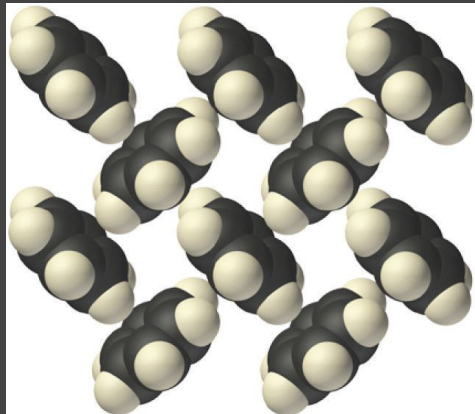

Image

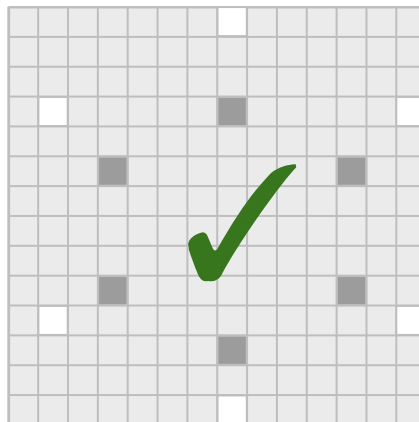

3D Coordinates

H	-0.21463	0.97837	0.33136
C	-0.38325	0.66317	-0.70334
C	-1.57552	0.03829	-1.05450
H	-2.34514	-0.13834	-0.29630
C	-1.78983	-0.36233	-2.36935
H	-2.72799	-0.85413	-2.64566
C	-0.81200	-0.13809	-3.33310
H	-0.98066	-0.45335	-4.36774
C	0.38026	0.48673	-2.98192
H	1.14976	0.66307	-3.74025
C	0.59460	0.88737	-1.66708
H	1.53276	1.37906	-1.39070

Many representations of benzene...

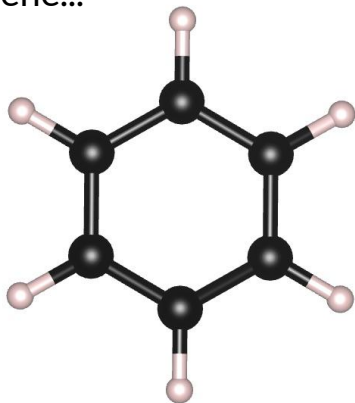

Vector (Fingerprint)



~~SMILES string:  
C1=CC=CC=C1~~

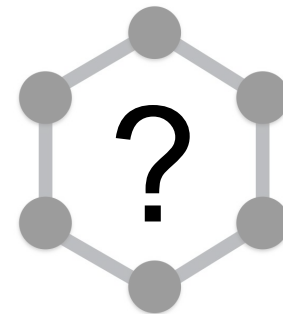

Graph of bonds

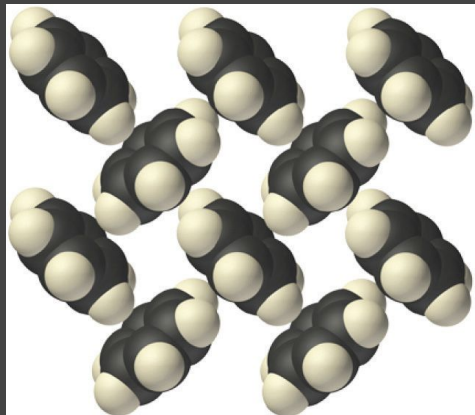

Image

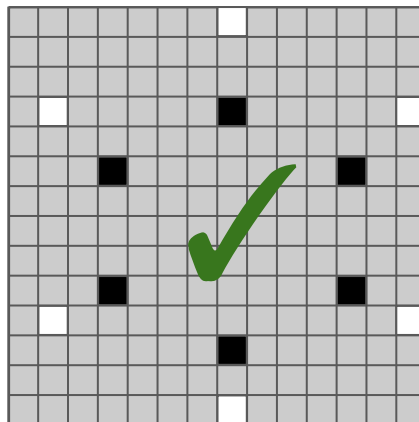

3D Coordinates

H	-0.21463	0.97837	0.33136
C	-0.38325	0.66317	-0.70334
C	-1.57552	0.03829	-1.05450
H	-2.34514	-0.13834	-0.29630
C	-1.78983	-0.36233	-2.36935
H	-2.72799	-0.85413	-2.64566
C	-0.81200	-0.13809	-3.33310
H	-0.98066	-0.45335	-4.36774
C	0.38026	0.48673	-2.98192
H	1.14976	0.66307	-3.74025
C	0.59460	0.88737	-1.66708
H	1.53276	1.37906	-1.39070

The following properties are useful for a network to have if one deals with geometry:

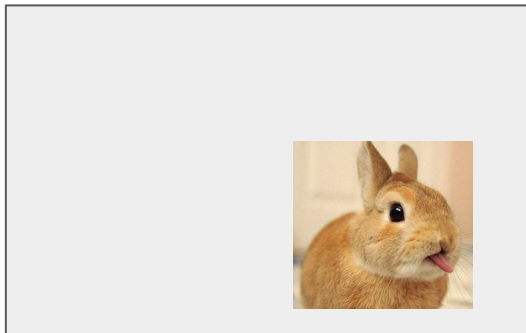
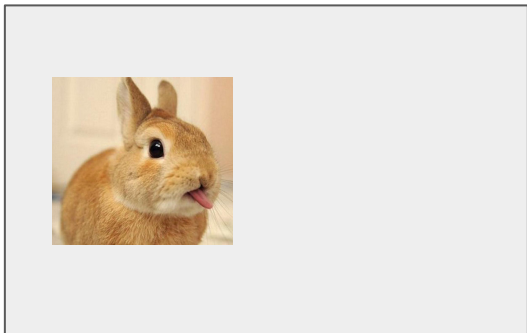

**Translation equivariance**

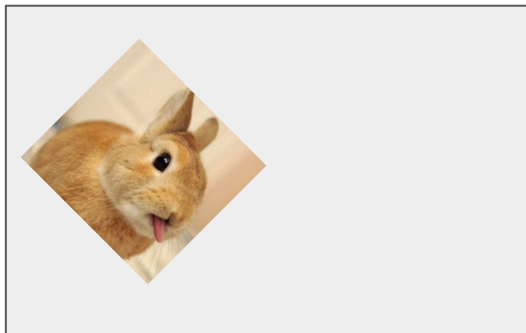
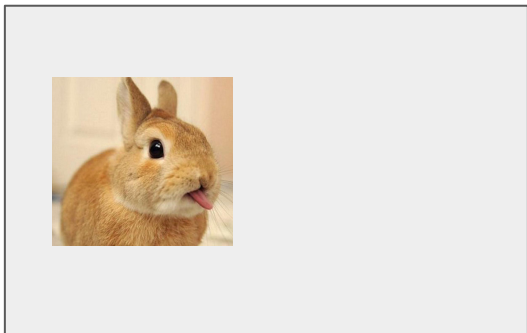

**Rotation equivariance**



The following properties are useful for a network to have if one deals with geometry:

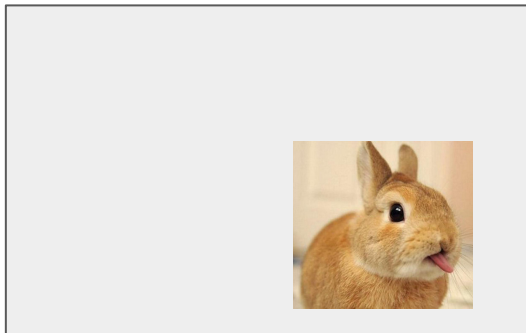
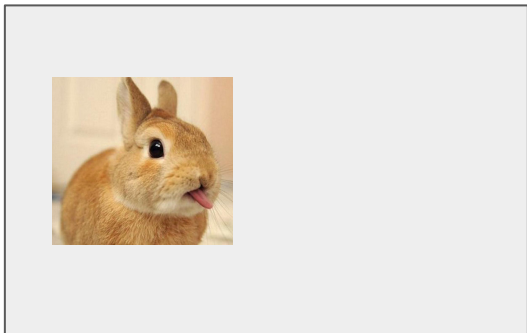

## Translation equivariance

Convolutional neural network ✓

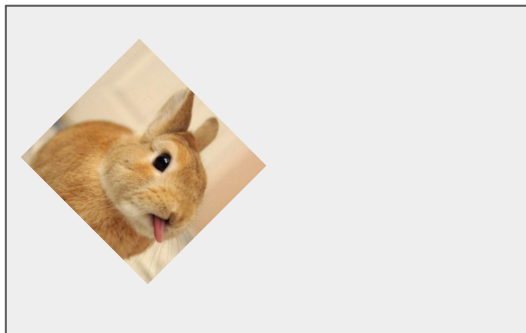
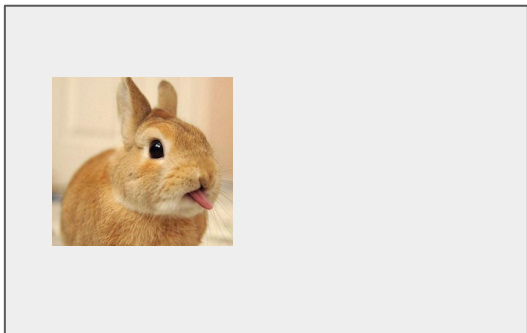

## Rotation equivariance?

The following properties are useful for a network to have if one deals with geometry:

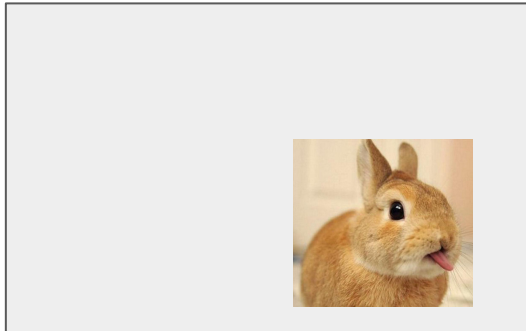
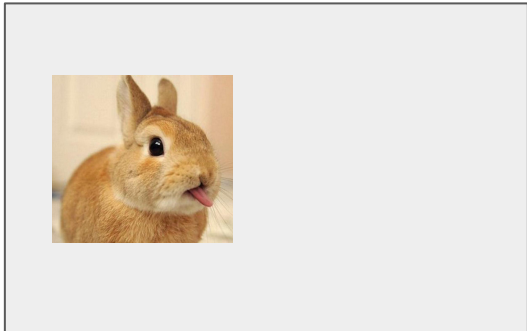

## **Translation equivariance**

Convolutional neural network ✓

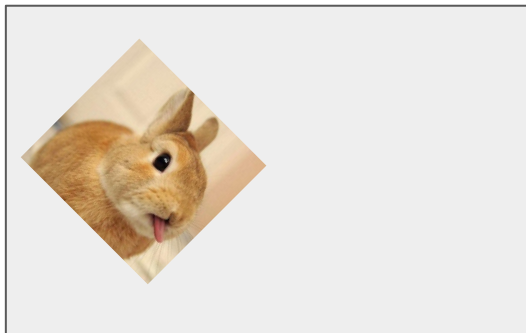
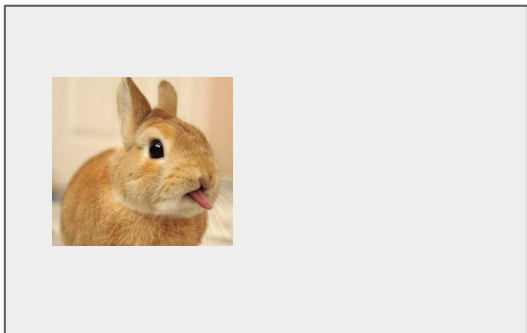

## **Rotation equivariance**

~~Data augmentation~~

~~Radial functions~~

*Want a network that both preserves geometry and exploits symmetry.*

A network with 3D translation- and 3D rotation-equivariance allows us to identify chemical motifs in any location or orientation using the same filters.

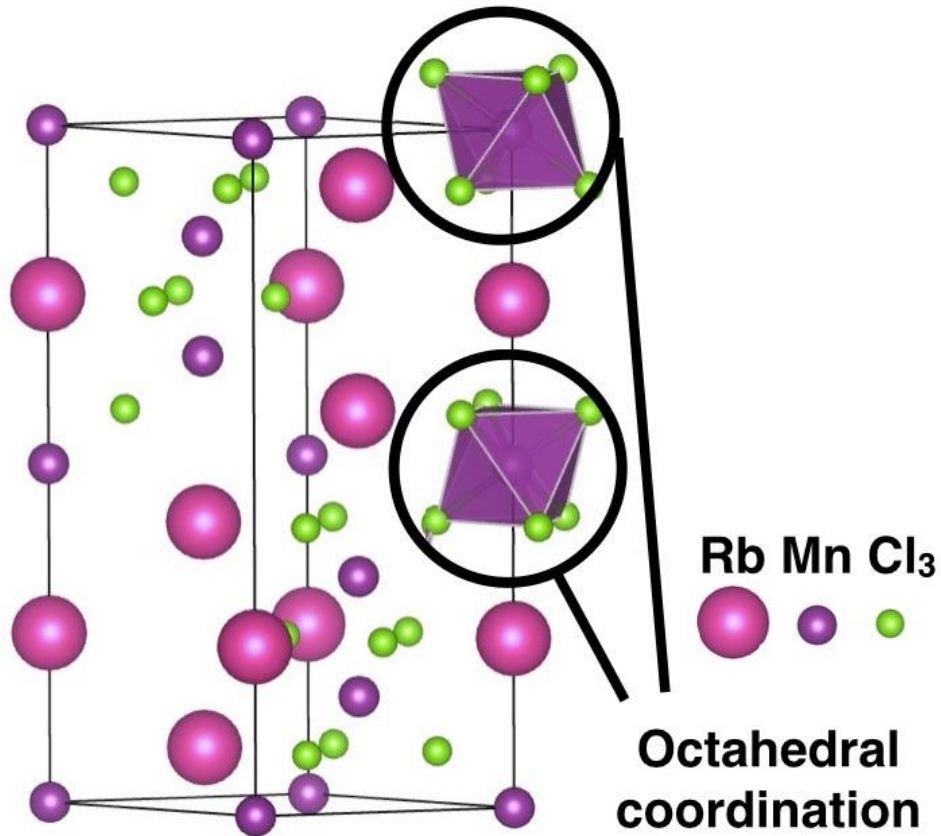

A network with 3D translation- and 3D rotation-equivariance allows us to identify chemical motifs in any location or orientation using the same filters.

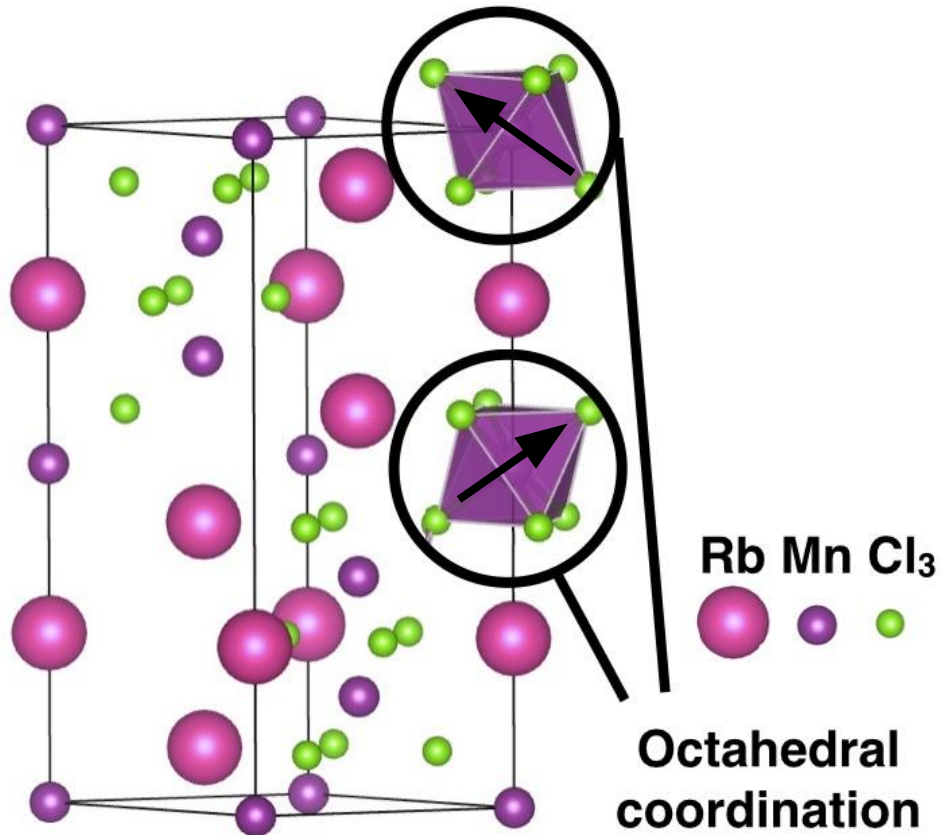

Previous networks applied to atomic systems **either**:

- cannot be extended to across all atomic systems (*molecules, materials, proteins, hybrid systems, nanoclusters, etc*) **or**
- throw out potentially useful geometric information.

Previous networks applied to atomic systems **either**:

- cannot be extended to across all atomic systems (*molecules, materials, proteins, hybrid systems, nanoclusters, etc*) **or**
- throw out potentially useful geometric information.

We created a framework for deep learning on atomic systems that can naturally handle 3D geometry and features of physical systems.

Stanford

Google Accelerated Science Team



Nate  
Thomas



Patrick  
Riley



Steve  
Kearnes



Lusann  
Yang



Li  
Li



Kai  
Kohlhoff

Previous networks applied to atomic systems **either**:

- cannot be extended to across all atomic systems (*molecules, materials, proteins, hybrid systems, nanoclusters, etc*) **or**
- throw out potentially useful geometric information.

We created a framework for deep learning on atomic systems that can naturally handle 3D geometry and features of physical systems.

arXiv:1802.08219

---

## Tensor Field Networks: Rotation- and Translation-Equivariant Neural Networks for 3D Point Clouds

---

Nathaniel Thomas<sup>\*1</sup> Tess Smidt<sup>\*234</sup> Steven Kearnes<sup>4</sup> Lusann Yang<sup>4</sup> Li Li<sup>4</sup> Kai Kohlhoff<sup>4</sup> Patrick Riley<sup>4</sup>

### Abstract

We introduce tensor field networks, which are locally equivariant to 3D rotations and translations (and invariant to permutations of points) at every layer. 3D rotation equivariance removes the need for data augmentation to identify features in arbitrary orientations. Our network uses filters built from spherical harmonics; due to the mathematical consequences of this filter choice, each

significantly more important in 3D than 2D. Without equivariant filters like those in our design, achieving an angular resolution of  $\delta$  would require a factor of  $\mathcal{O}(\delta^{-1})$  more filters in 2D but  $\mathcal{O}(\delta^{-3})$  more filters in 3D.<sup>1</sup> Second, a 3D rotation- and translation-equivariant network can identify local features in different orientations and locations with the same filters, which is helpful for interpretability. Finally, the network naturally encodes geometric tensors (such as scalars, vectors, and higher-rank geometric objects), mathematical objects that transform predictably under geometric

Previous networks applied to atomic systems **either**:

- cannot be extended to across all atomic systems (*molecules, materials, proteins, hybrid systems, nanoclusters, etc*) **or**
- throw out potentially useful geometric information.

We created a framework for deep learning on atomic systems that can naturally handle 3D geometry and features of physical systems.

## TLDR

Spherical harmonics

$$Y_l^m$$

L = 0



L = 1



L = 2



L = 3



m = -3

m = -2

m = -1

m = 0

m = 1

m = 2

m = 3

Convolutional filters based on spherical harmonics and learned radial functions

Everything in our network is a **geometric tensor**, so our network connectivity has to obey **tensor algebra**.

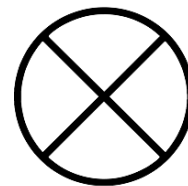



# What's a tensor product?



scalar multiplication makes sense:

"scalar"  
from a  
field  $F$

$$c\vec{v} = \text{okay!}$$

"vector" from a  
vector space,  $V$



but what if we want to multiply two vectors?



from another  
vector space,  $U$

???

$$\vec{u} \text{ "times" } \vec{v} = \text{CONFUSION! ?}$$



what do we mean by "times"??

ANSWER: the TENSOR PRODUCT!

$$U \otimes_F V$$

**Test of 3D rotation equivariance:** Trained on 3D Tetris shapes in one orientation, our network can perfectly identify these shapes in any orientation.

**TRAIN**

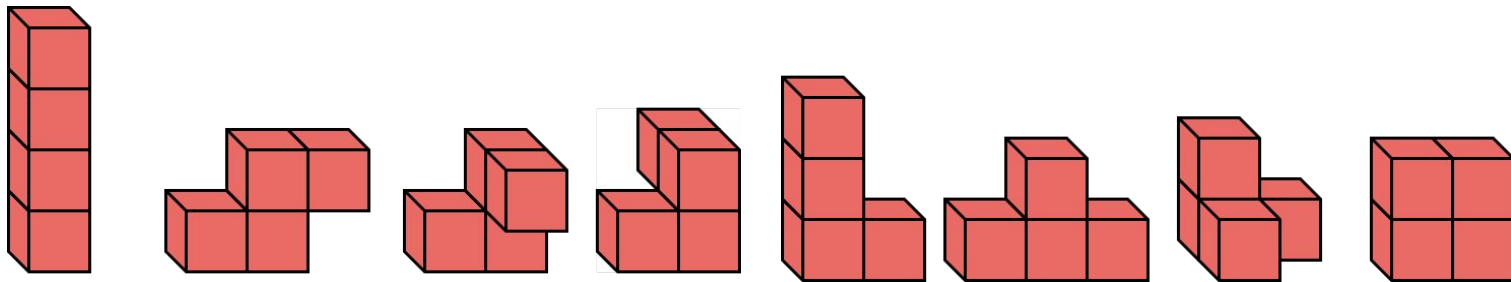

**TEST**

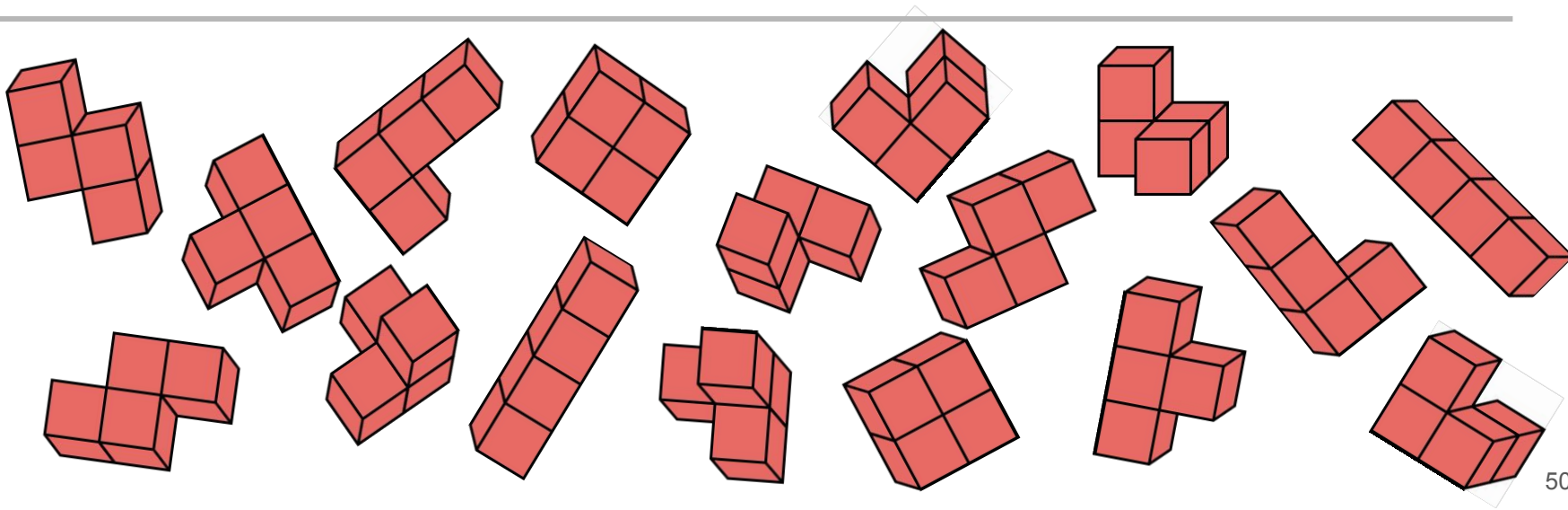

**Test of 3D rotation equivariance:** Trained on 3D Tetris shapes in one orientation, our network can perfectly identify these shapes in any orientation.

**TRAIN**

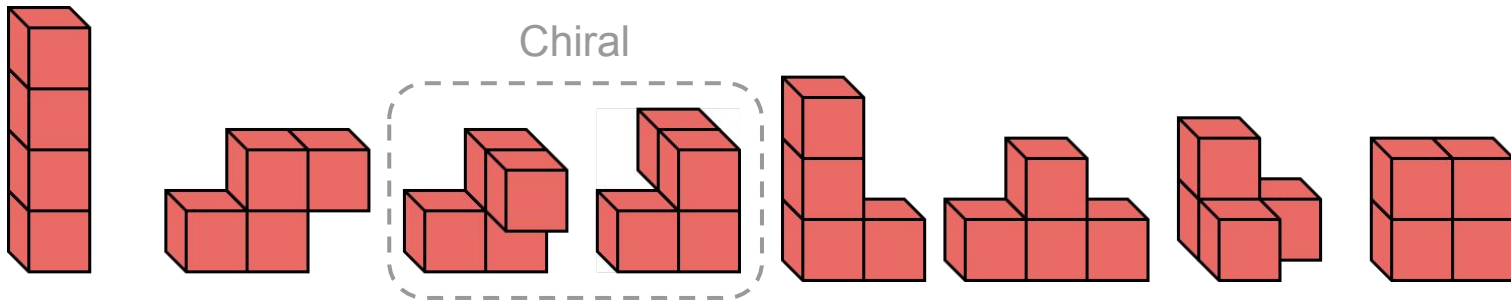

**TEST**

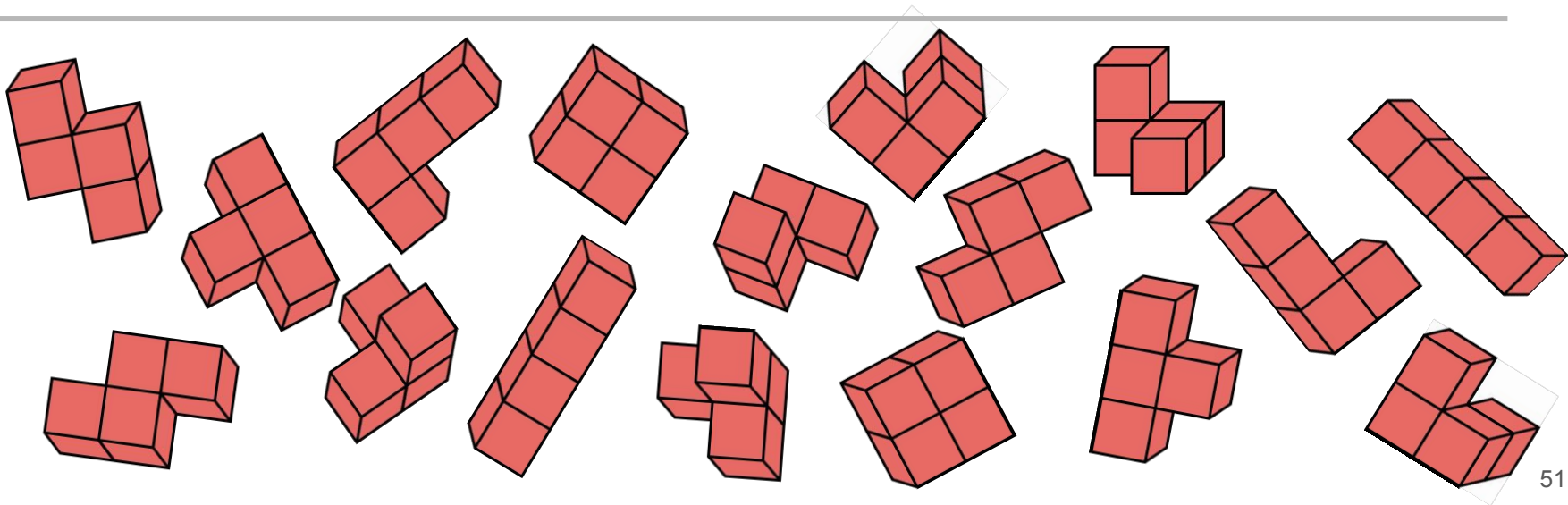

Autoencoders can learn how map data in its original representation to a new representation and back again.

The learned representation is often very useful.

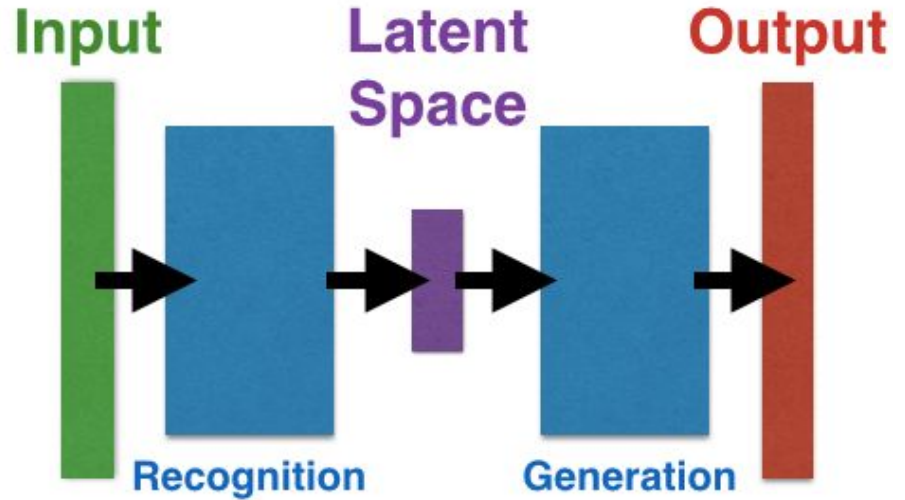

Want **Input** = **Output**

Latent space is either small or has a penalty to have a specified distribution.

Example  
MNIST digits:



2 dimensional latent  
space for autoencoder  
trained on MNIST  
handwritten digit images

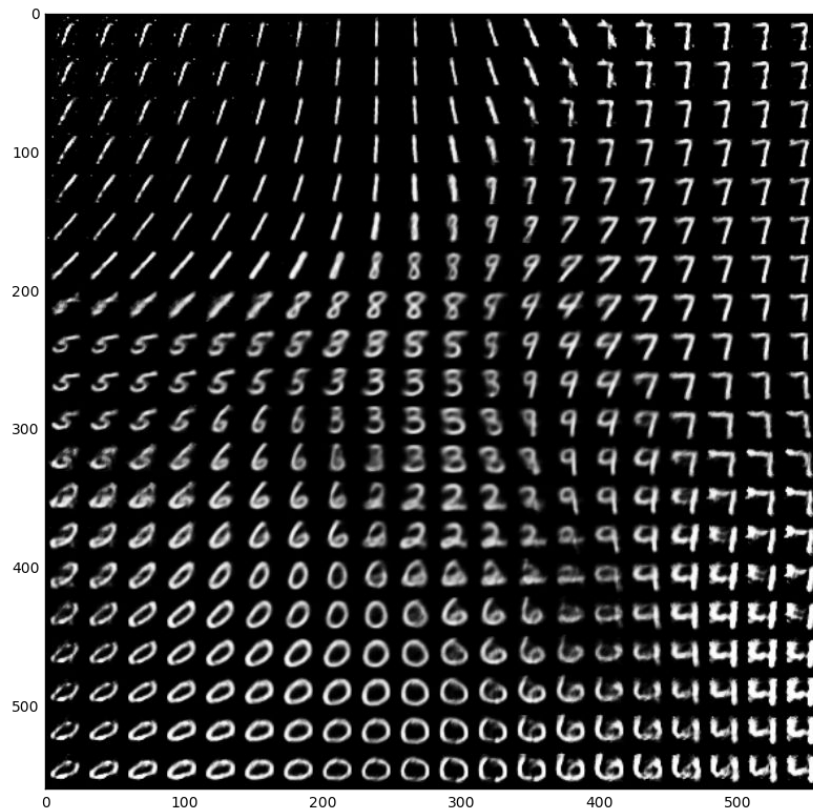

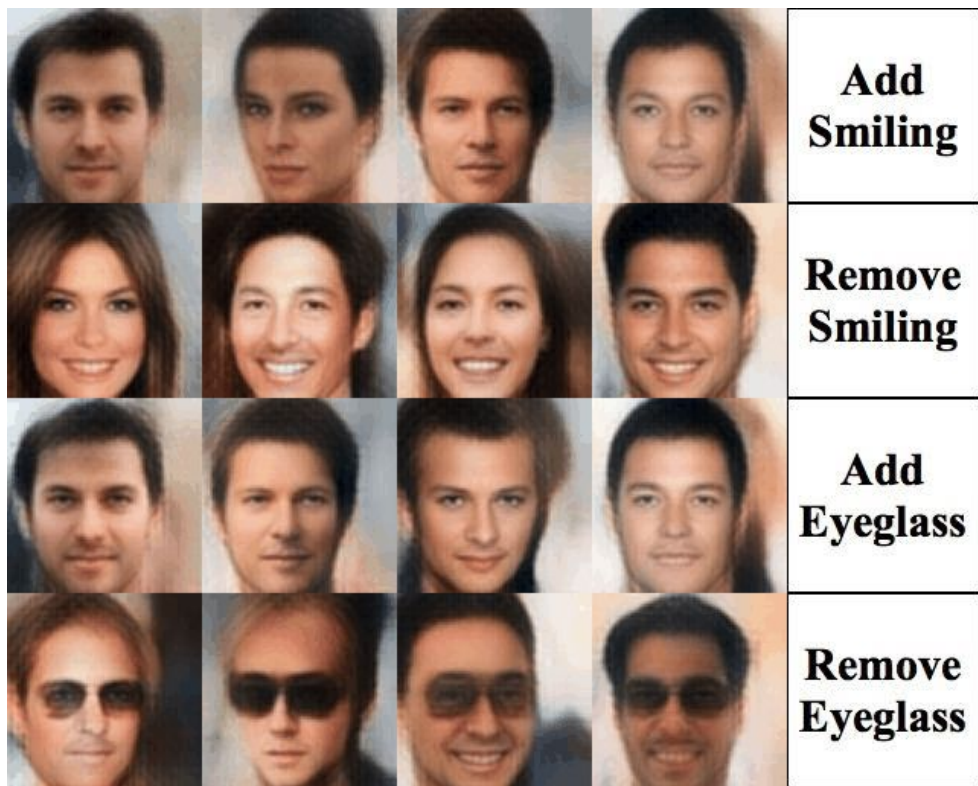

<https://houxianxu.github.io/assets/project/dfcvae>

<https://twitter.com/smilevector>

**An autoencoder trained on atomic systems would solve multiple problems at once.**

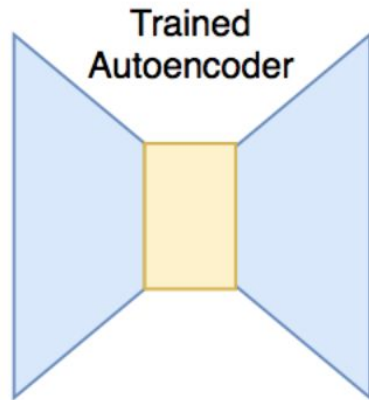

**An autoencoder trained on atomic systems would solve multiple problems at once.**

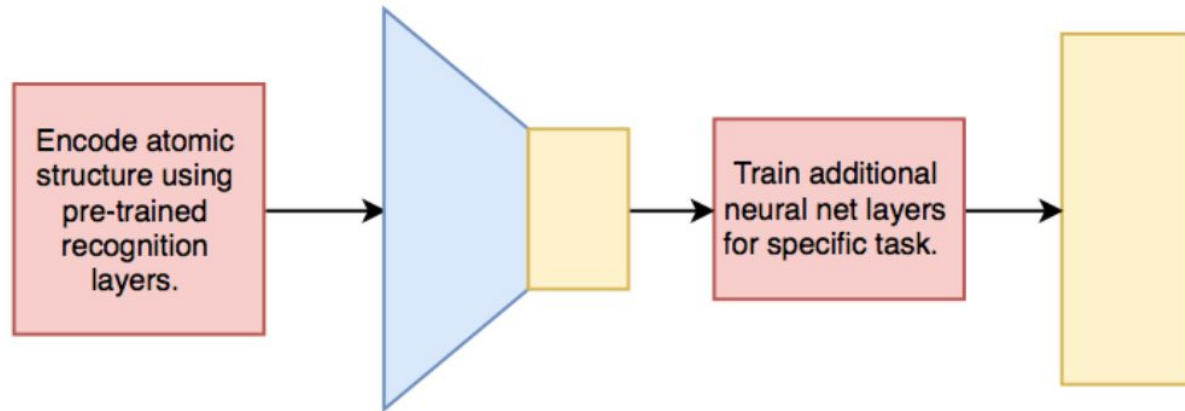
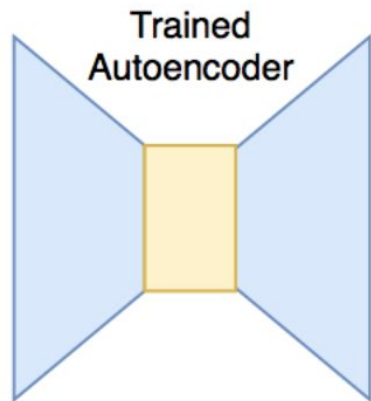



An autoencoder trained on atomic systems would solve multiple problems at once.

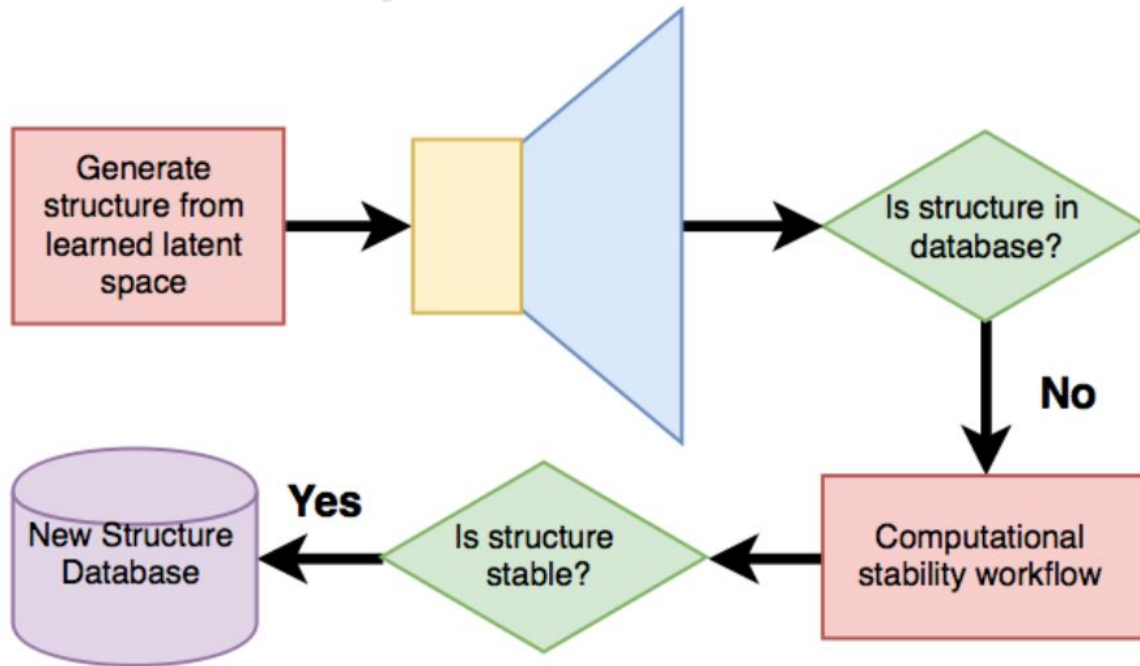
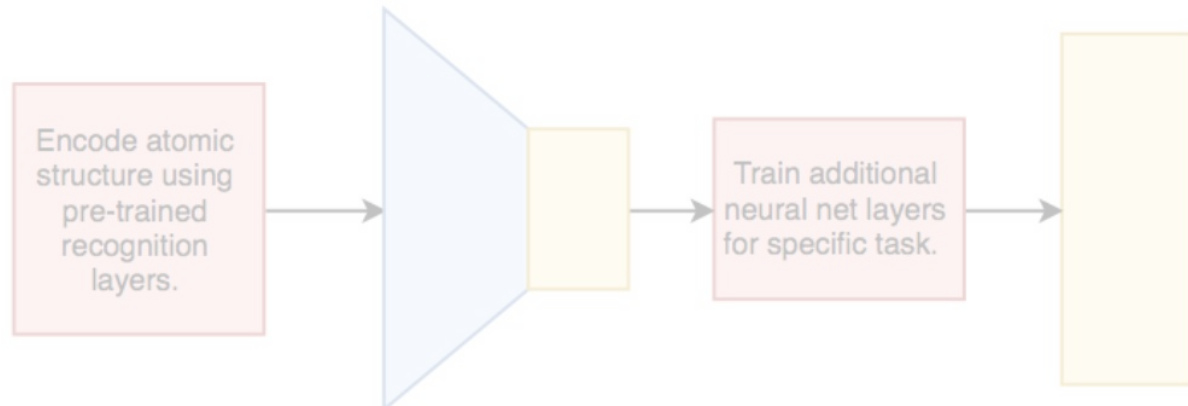
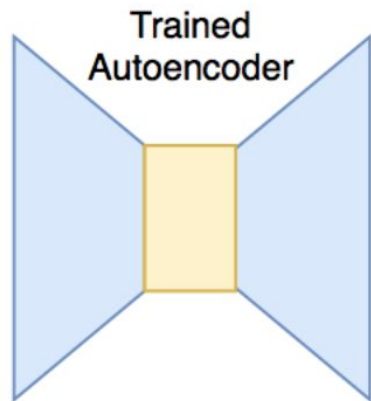

**An autoencoder trained on atomic systems would solve multiple problems at once.**

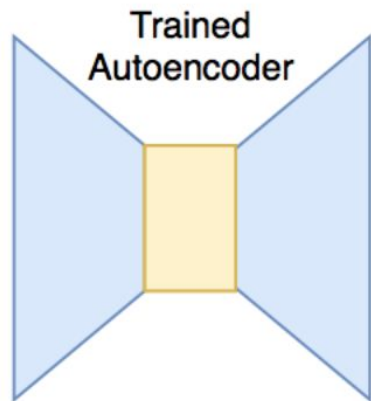

The latent space would provide a "materials map".

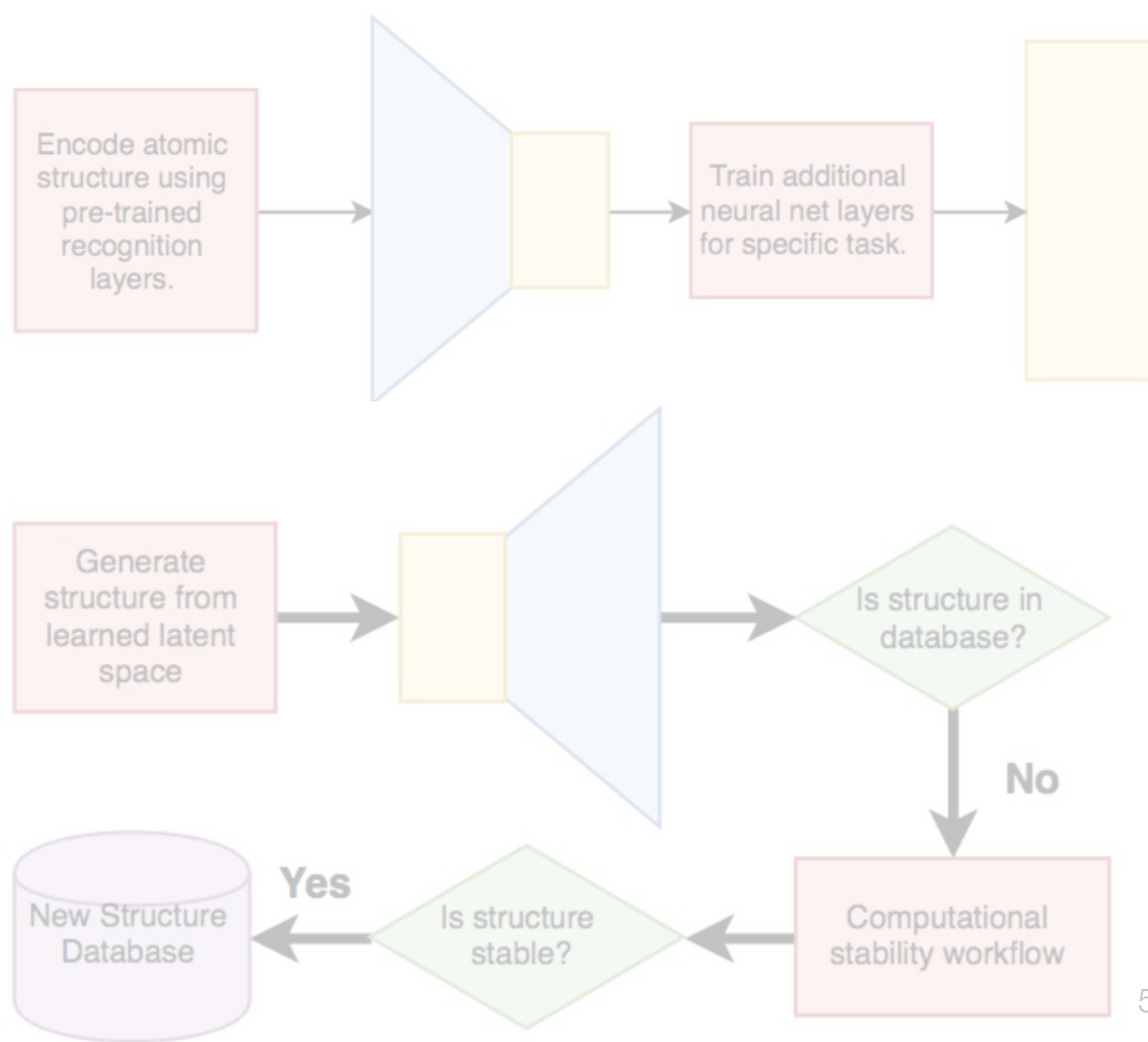

## Creating an autoencoder for discrete geometry

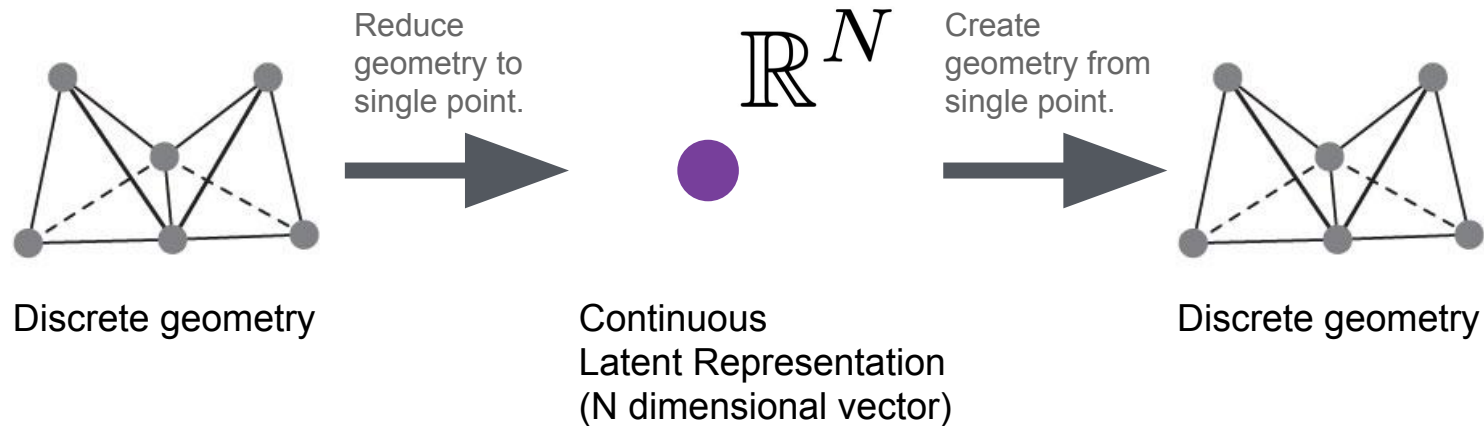

## Creating an autoencoder for discrete geometry

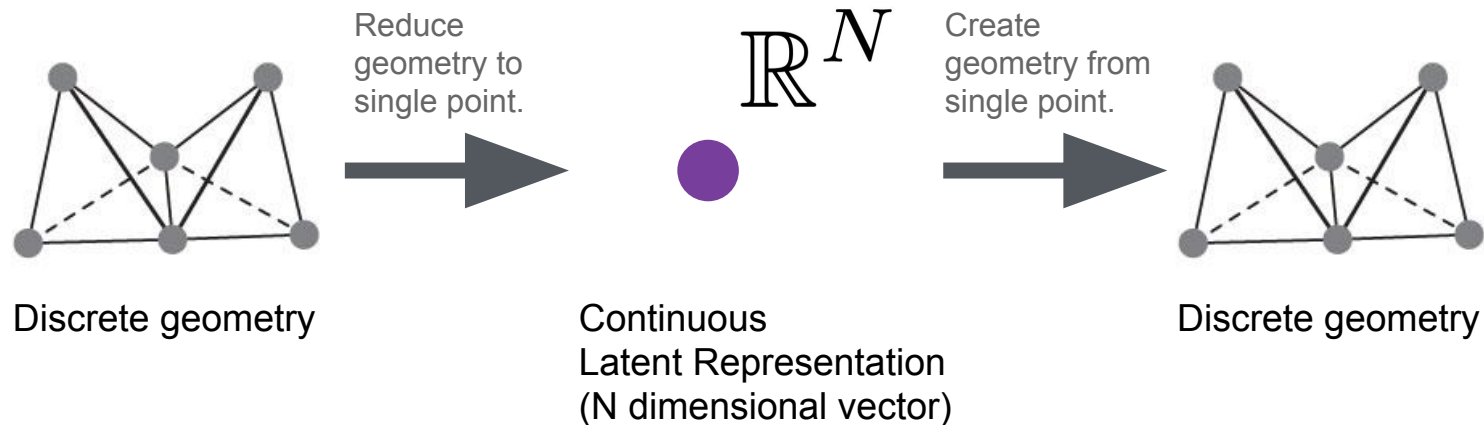

Atomic structures are hierarchical and can be constructed from geometric motifs.

- + **Encode geometry** ✓
  - + Encode hierarchy
  - + Decode geometry
  - + Decode hierarchy
- (Need to do this in a recursive manner)

**Okay, so how did I get here?**

# **My Thesis:** Toward designing complex materials from structural motifs (The TLDR; version)

## Ch 1: Introduction

## Ch 2: Methods (DFT)

## Ch 3: Realization of a three-dimensional spin-anisotropic harmonic honeycomb iridate

- K. Modic, T. Smidt et al, Nature Communications 5 (2014).

## Ch 4: Ab initio Studies of Structural and Energetic Trends in the Harmonic Honeycomb Iridates

- T. Smidt et al, To be submitted to Physical Review B (2018)

## Ch 5: Silver Benzeneselenolate is a Self-Assembling Direct-Gap Metal-Organic Chalcogenide Assembly

- M. Collins, T. Smidt et al, In preparation.

## Ch 6: An Automatically Curated First-Principles Database of Ferroelectrics

- T. Smidt et al, Submitted to Nature Scientific Data (2018)

## Ch 7: Tensor field networks: Rotation- and Translation-Equivariant Neural Networks for 3D Point Clouds

- N. Thomas\*, T. Smidt\* et al, arXiv:1802.08219

## Ch 8: Outlook

# **My Thesis:** Toward designing complex materials from structural motifs (The TLDR; version)

## Ch 1: Introduction

## Ch 2: Methods (DFT)

## Ch 3: Realization of a three-dimensional spin-anisotropic harmonic honeycomb iridate

- K. Modic, T. Smidt et al, Nature Communications 5 (2014).

## Ch 4: Ab initio Studies of Structural and Energetic Trends in the Harmonic Honeycomb Iridates

- T. Smidt et al, To be submitted to Physical Review B (2018)

## **(INSERT EXISTENTIAL RESEARCH CRISIS -- 3rd year)**

## Ch 5: Silver Benzeneselenolate is a Self-Assembling Direct-Gap Metal-Organic Chalcogenide Assembly

- M. Collins, T. Smidt et al, In preparation.

## Ch 6: An Automatically Curated First-Principles Database of Ferroelectrics

- T. Smidt et al, Submitted to Nature Scientific Data (2018)

## Ch 7: Tensor field networks: Rotation- and Translation-Equivariant Neural Networks for 3D Point Clouds

- N. Thomas\*, T. Smidt\* et al, arXiv:1802.08219

## Ch 8: Outlook

# The Lunch Experiment: Randomized Controlled Lunches for Grad Students

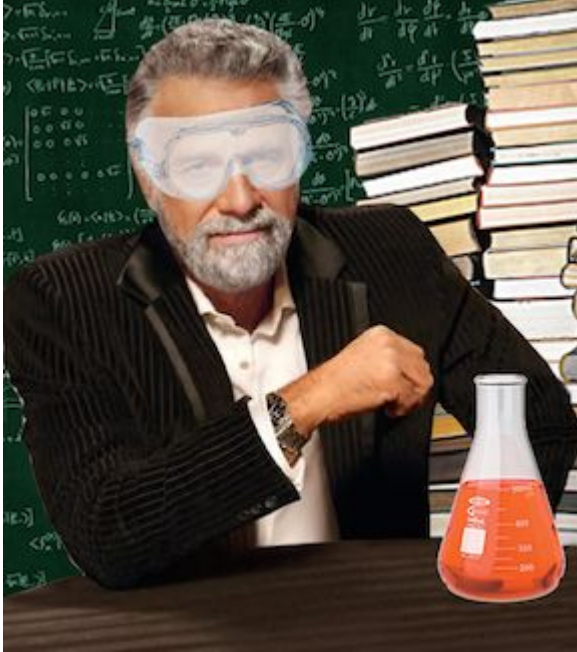

**I don't always eat lunch, but when I do,  
I prefer The Lunch Experiment.**

400+ participants  
100+ lunches

Automated scheduling and invitation system  
maximizing for diversity of majors.





# **My Thesis:** Toward designing complex materials from structural motifs (The TLDR; version)

## Ch 1: Introduction

## Ch 2: Methods (DFT)

## Ch 3: Realization of a three-dimensional spin-anisotropic harmonic honeycomb iridate

- K. Modic, T. Smidt et al, Nature Communications 5 (2014).

## Ch 4: Ab initio Studies of Structural and Energetic Trends in the Harmonic Honeycomb Iridates

- T. Smidt et al, To be submitted to Physical Review B (2018)

## **(INSERT EXISTENTIAL RESEARCH CRISIS -- 3rd year)**

## Ch 5: Silver Benzeneselenolate is a Self-Assembling Direct-Gap Metal-Organic Chalcogenide Assembly

- M. Collins, T. Smidt et al, In preparation.

## Ch 6: An Automatically Curated First-Principles Database of Ferroelectrics

- T. Smidt et al, Submitted to Nature Scientific Data (2018)

## Ch 7: Tensor field networks: Rotation- and Translation-Equivariant Neural Networks for 3D Point Clouds

- N. Thomas\*, T. Smidt\* et al, arXiv:1802.08219

## Ch 8: Outlook

# **My Thesis:** Toward designing complex materials from structural motifs (The TLDR; version)

## Ch 1: Introduction

## Ch 2: Methods (DFT)

## Ch 3: Realization of a three-dimensional spin-anisotropic harmonic honeycomb iridate

- K. Modic, T. Smidt et al, Nature Communications 5 (2014).

## Ch 4: Ab initio Studies of Structural and Energetic Trends in the Harmonic Honeycomb Iridates

- T. Smidt et al, To be submitted to Physical Review B (2018)

## **(INSERT EXISTENTIAL RESEARCH CRISIS -- 3rd year)**

## Ch 5: Silver Benzeneselenolate is a Self-Assembling Direct-Gap Metal-Organic Chalcogenide Assembly

- M. Collins, T. Smidt et al, In preparation.

## Ch 6: An Automatically Curated First-Principles Database of Ferroelectrics

- T. Smidt et al, Submitted to Nature Scientific Data (2018)

## **(DEEP LEARNING AND GOOGLE -- 5-6th years)**

## Ch 7: Tensor field networks: Rotation- and Translation-Equivariant Neural Networks for 3D Point Clouds

- N. Thomas\*, T. Smidt\* et al, arXiv:1802.08219

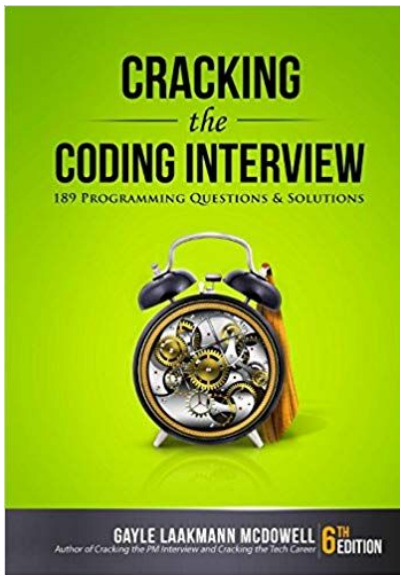

+

CS 182/282A

=



**Spring 2019** COMPSCI 282A 001 - LEC 001 offered through **Electrical Engineering and Computer Sciences**

## Designing, Visualizing and Understanding Deep Neural Networks

 John F Canny

 M, W

Class #: 31116

 8:00 am - 9:29 am

Units: 4

 Dwinelle 145

### Open Seats

30 Unreserved Seats

Deep Networks have revolutionized computer vision, language technology, robotics and control. They have growing impact in many other areas of science and engineering. They do not however, follow a closed or compact set of theoretical principles. In Yann Lecun's words they require "an interplay between intuitive insights, theoretical modeling, practical implementations, empirical studies, and...



# **My Thesis:** Toward designing complex materials from structural motifs (The TLDR; version)

## Ch 1: Introduction

## Ch 2: Methods (DFT)

## Ch 3: Realization of a three-dimensional spin-anisotropic harmonic honeycomb iridate

- K. Modic, T. Smidt et al, Nature Communications 5 (2014).

## Ch 4: Ab initio Studies of Structural and Energetic Trends in the Harmonic Honeycomb Iridates

- T. Smidt et al, To be submitted to Physical Review B (2018)

## **(INSERT EXISTENTIAL RESEARCH CRISIS -- 3rd year)**

## Ch 5: Silver Benzeneselenolate is a Self-Assembling Direct-Gap Metal-Organic Chalcogenide Assembly

- M. Collins, T. Smidt et al, In preparation.

## Ch 6: An Automatically Curated First-Principles Database of Ferroelectrics

- T. Smidt et al, Submitted to Nature Scientific Data (2018)

## **(DEEP LEARNING AND GOOGLE -- 5-6th years)**

## Ch 7: Tensor field networks: Rotation- and Translation-Equivariant Neural Networks for 3D Point Clouds

- N. Thomas\*, T. Smidt\* et al, arXiv:1802.08219

## In summary...

There's a lot of work to do in applying deep learning methods for tasks in atomic systems. Methods may not work out of the box. Many technical design choices to make and test.

Google is an amazing place to work. I highly recommend interning during grad school if you can.

Berkeley Lab is in a great position to play a central role in how ML methods are adopted in the chemistry and materials communities.

### **Review on ML for molecules and materials:**

*Machine learning for molecular and materials science*

Keith T. Butler, Daniel W. Davies, Hugh Cartwright,

Olexandr Isayev & Aron Walsh

Nature **559**, 547–555 (2018).

<https://doi.org/10.1038/s41586-018-0337-2>

**Come visit and chat about DL for atomic systems! My office is 50F-1643.**

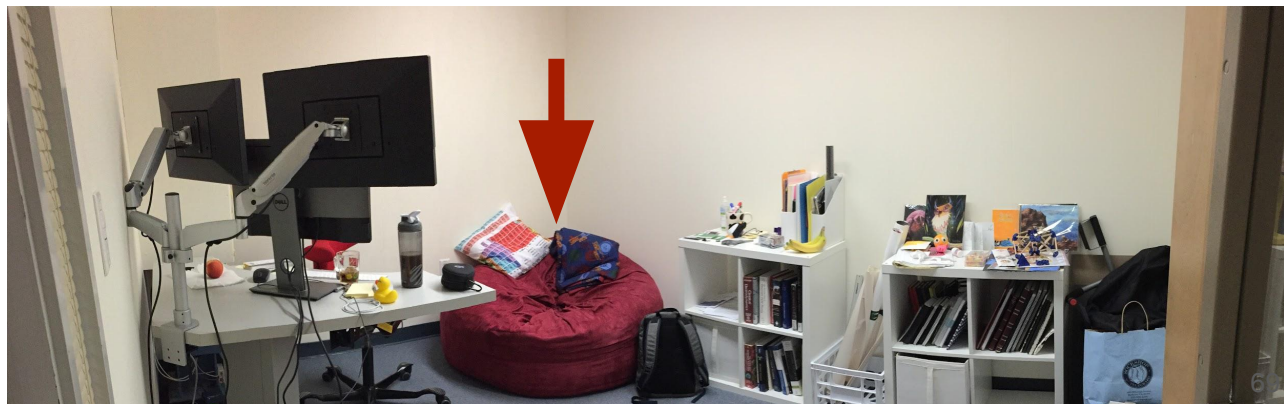
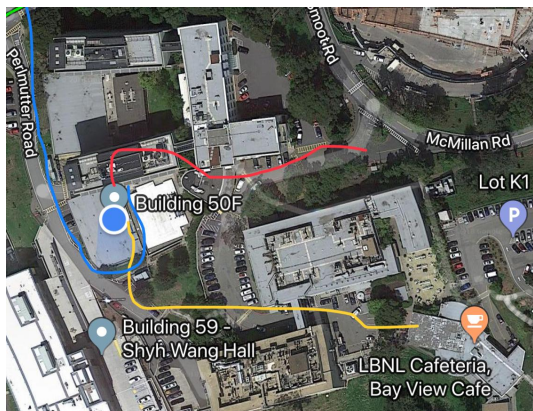

Calling in backup (slides)!



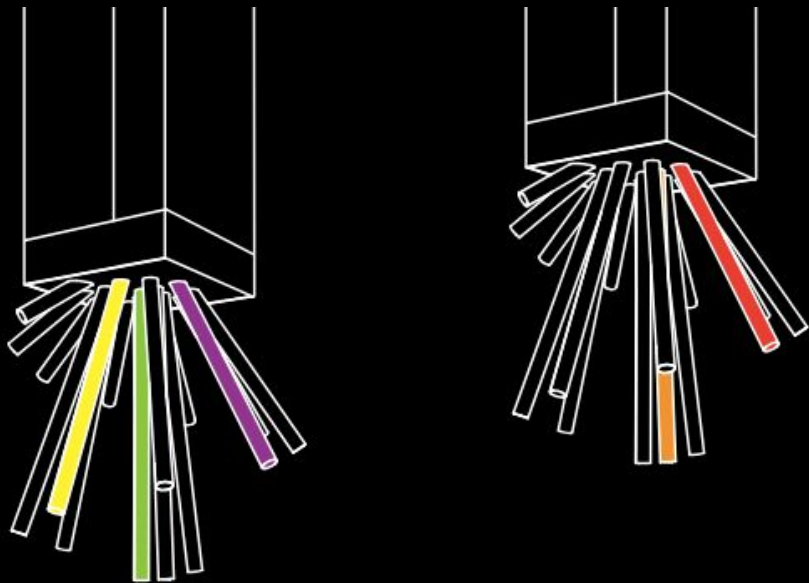

# *Cosmic Ray Chandeliers*

*2011 Mixed Medium*

TESS SMIDT // NATHANIEL THOMAS  
MICHAEL STUNES // CHRISTY SWARTZ

ABOUT

HOW IT WORKS

VIDEO & PHOTOS

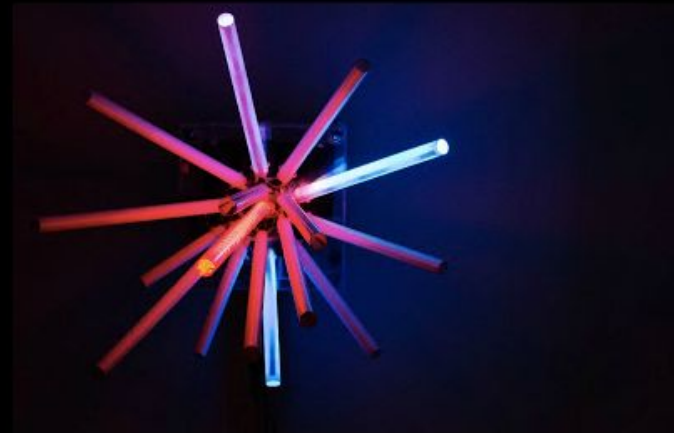



**We use points. Images of atomic systems are sparse and imprecise.**

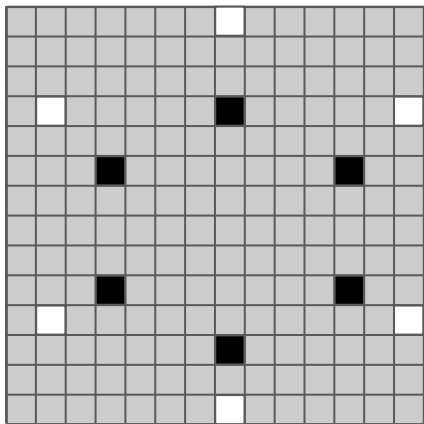

**VS.**

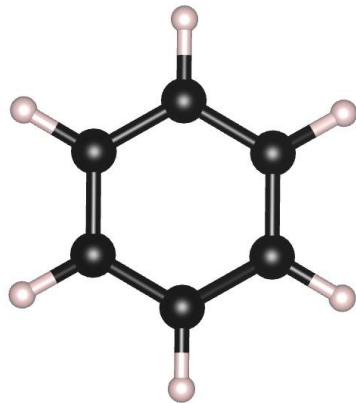

**We use continuous convolutions with atoms as convolution centers.**

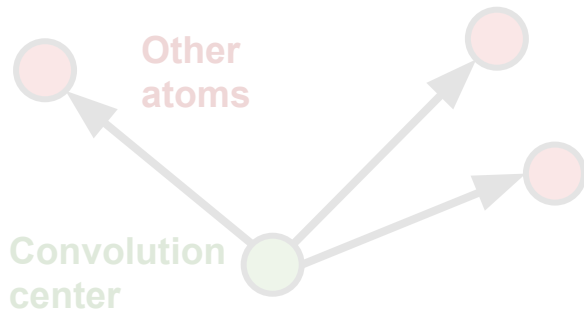

K. T. Schütt, P.-J. Kindermans, H. E. Sauceda, S. Chmiela, A. Tkatchenko, and K.-R. Müller, Adv. in Neural Information Processing Systems 30 (2017). (arXiv: 1706.08566)

**We encode the symmetries of 3D Euclidean space (3D translation- and 3D rotation-equivariance).**

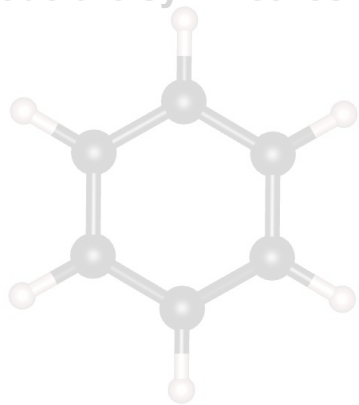

$$g \in SE(3)$$

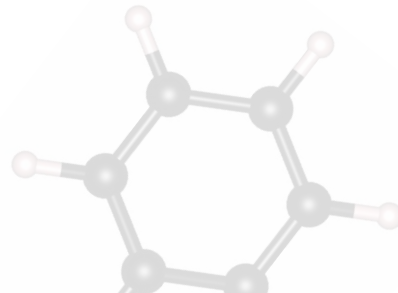



We use points. Images of atomic systems are sparse and imprecise.

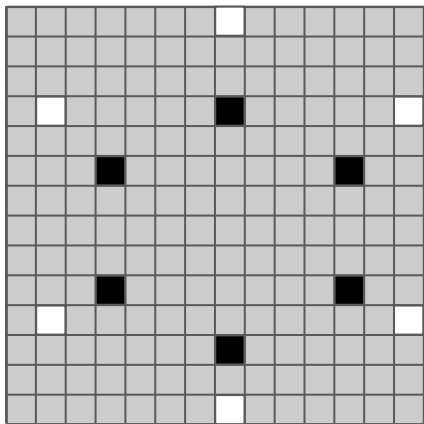

VS.

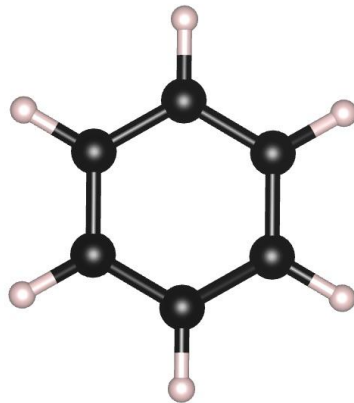

We use continuous convolutions with atoms as convolution centers.

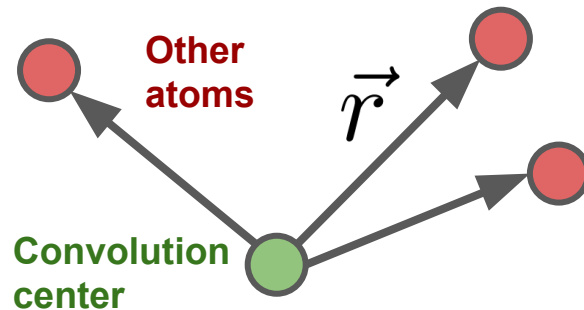

K. T. Schütt, P.-J. Kindermans, H. E. Sauceda, S. Chmiela, A. Tkatchenko, and K.-R. Müller, Adv. in Neural Information Processing Systems 30 (2017). (arXiv: 1706.08566)

We encode the symmetries of 3D Euclidean space (3D translation- and 3D rotation-equivariance).

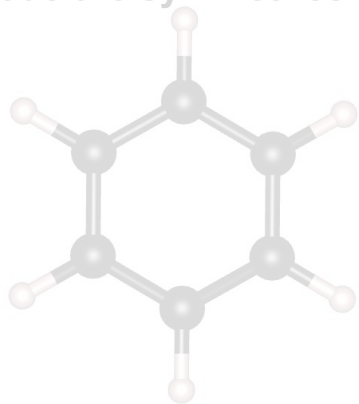

$$g \in SE(3)$$

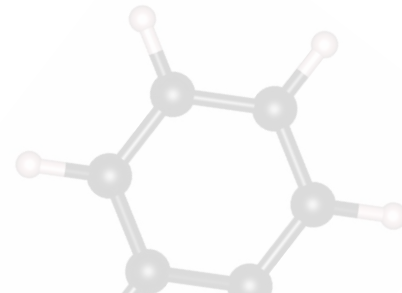

We use points. Images of atomic systems are sparse and imprecise.

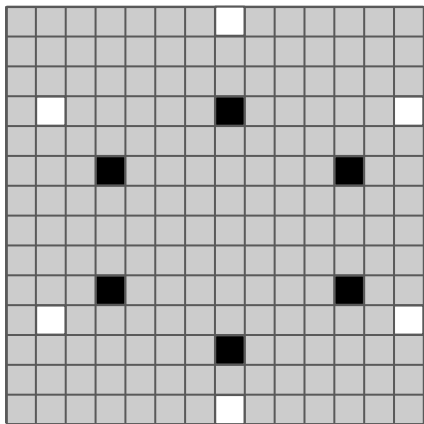

VS.



We use continuous convolutions with atoms as convolution centers.

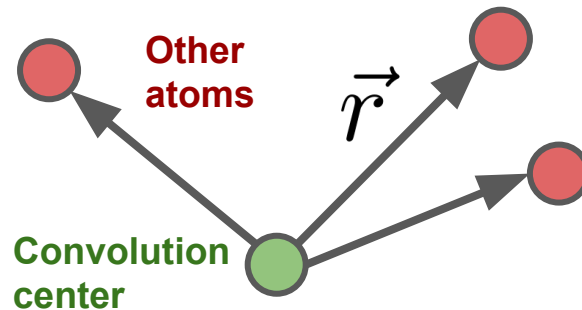

K. T. Schütt, P.-J. Kindermans, H. E. Sauceda, S. Chmiela, A. Tkatchenko, and K.-R. Müller, Adv. in Neural Information Processing Systems 30 (2017). (arXiv: 1706.08566)

We encode the symmetries of 3D Euclidean space (3D translation- and 3D rotation-equivariance).

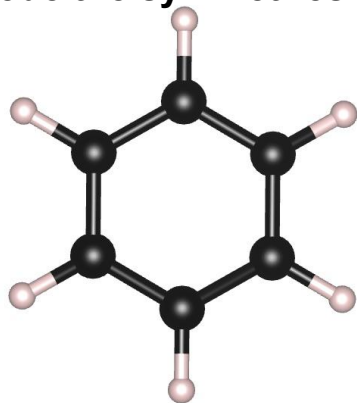

$$g \in SE(3)$$

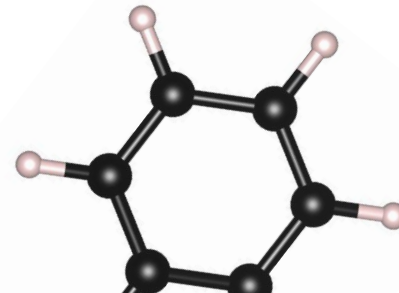

We use points. Images of atomic systems are sparse and imprecise.

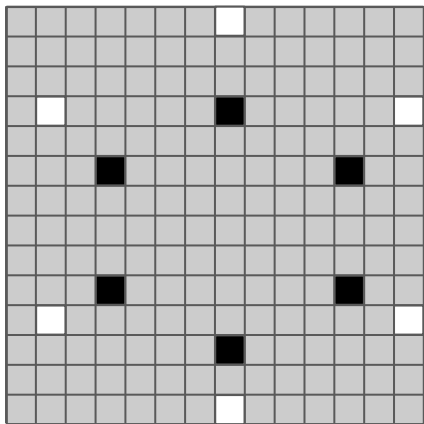

VS.

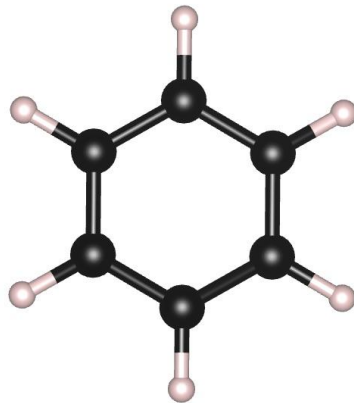

We use continuous convolutions with atoms as convolution centers.

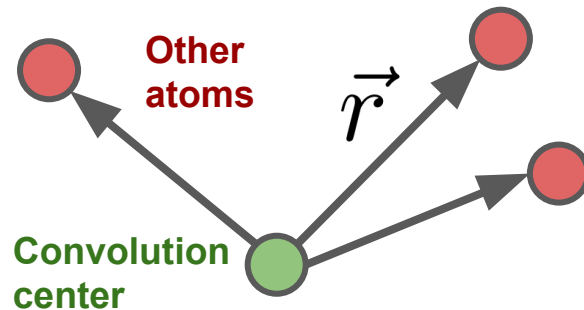

K. T. Schütt, P.-J. Kindermans, H. E. Sauceda, S. Chmiela, A. Tkatchenko, and K.-R. Müller, Adv. in Neural Information Processing Systems 30 (2017). (arXiv: 1706.08566)

We encode the symmetries of 3D Euclidean space (3D translation- and 3D rotation-equivariance).

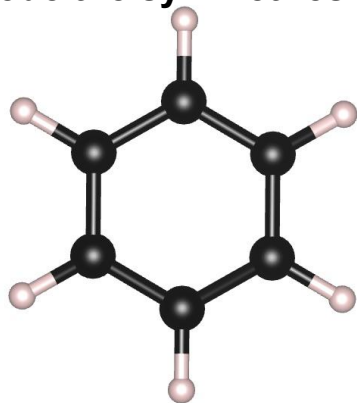

$$g \in SE(3)$$

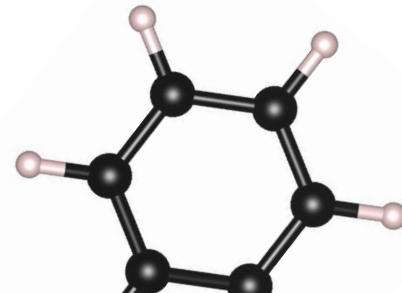

## Convolutional kernels...

with no symmetry:

$$W(\vec{r})$$

Learned  
Parameters

with 3D rotation equivariance:

$$R(r) Y_l^m(\hat{r})$$

# Spherical harmonics

$$Y_l^m$$

$L = 0$



angular portion of  
hydrogenic wavefunctions

basis functions for  $(2l + 1)$   
dimensional irreducible  
representations of  $SO(3)$

$L = 1$



$L = 2$

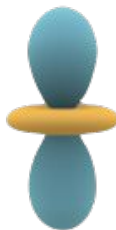
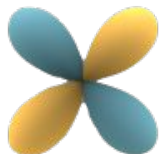

$L = 3$



$m = -3$

$m = -2$

$m = -1$

$m = 0$

$m = 1$

$m = 2$

$m = 3$

[Inigo quilez](https://en.wikipedia.org/wiki/Spherical_harmonics)

[https://en.wikipedia.org/wiki/Spherical\\_harmonics](https://en.wikipedia.org/wiki/Spherical_harmonics)

# Spherical harmonics

$$Y_l^m$$

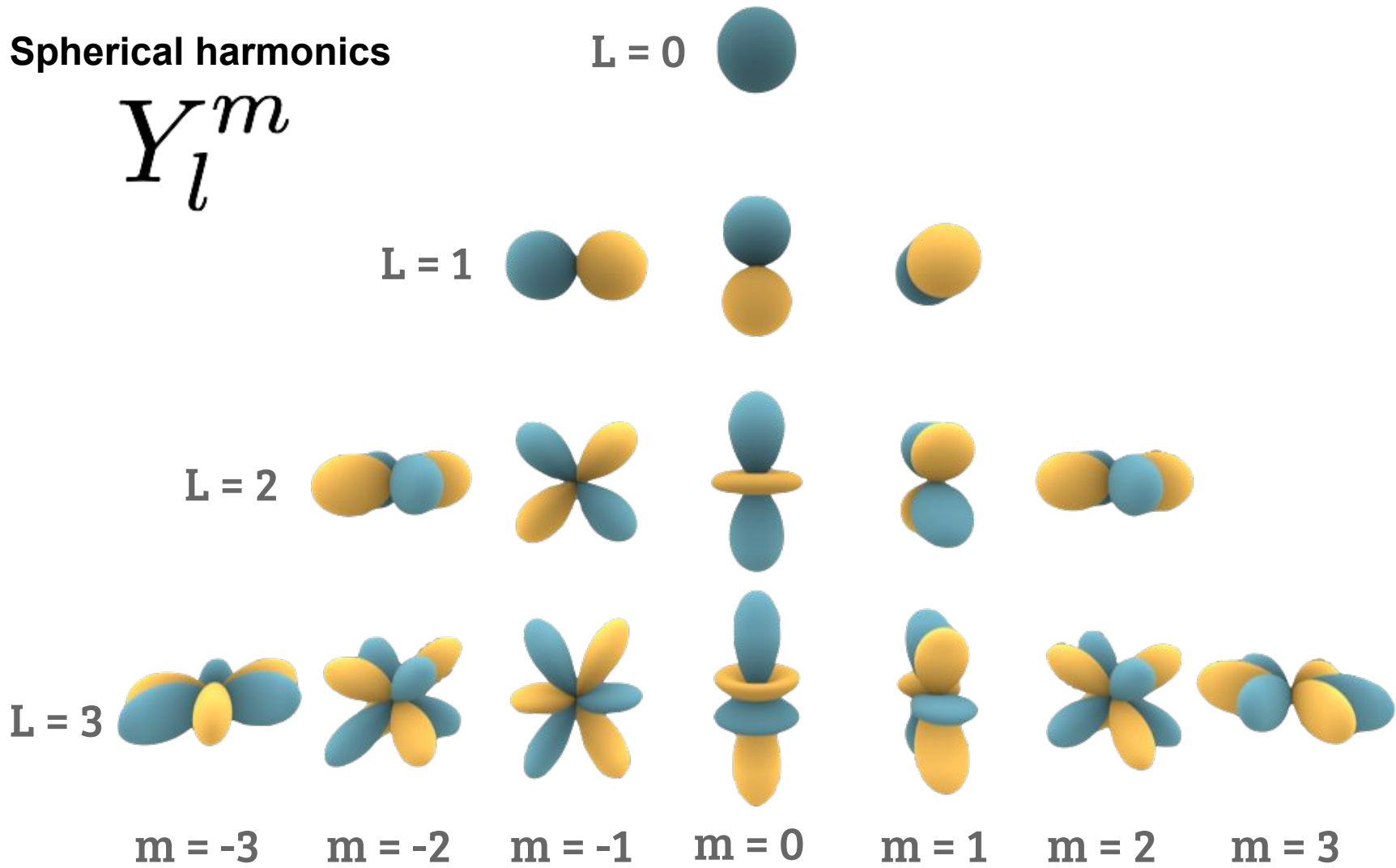

## Convolutional kernels...

with no symmetry:

$$W(\vec{r})$$

Learned  
Parameters

with 3D rotation equivariance:

$$R(r) Y_l^m(\hat{r})$$

Our filter choice requires the input, filters, and output of our network to be **geometric tensors** and our network connectivity to be compatible with **tensor algebra**.

(Everything has L and M indices like the spherical harmonics.)

Geometric tensors transform predictably under 3D rotation.

Two point **masses** with **velocity** and **acceleration**.

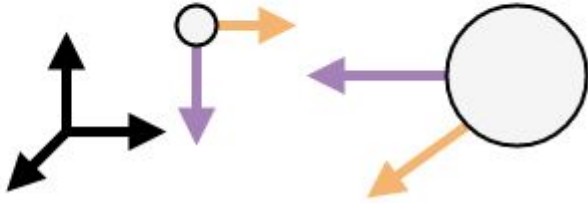

Same system, with rotated coordinates.

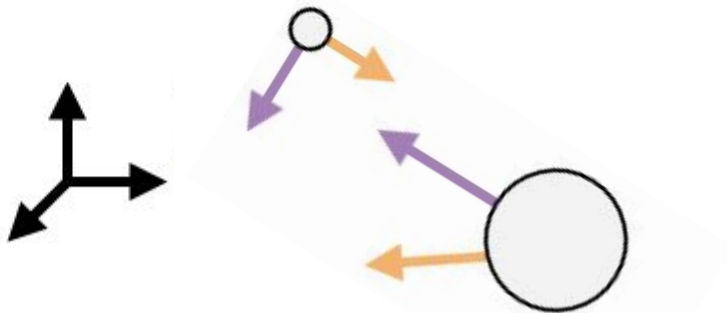



Geometric tensors transform predictably under 3D rotation.

Two point masses with **velocity** and **acceleration**.

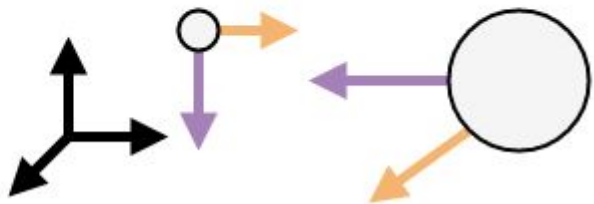

Same system, with rotated coordinates.

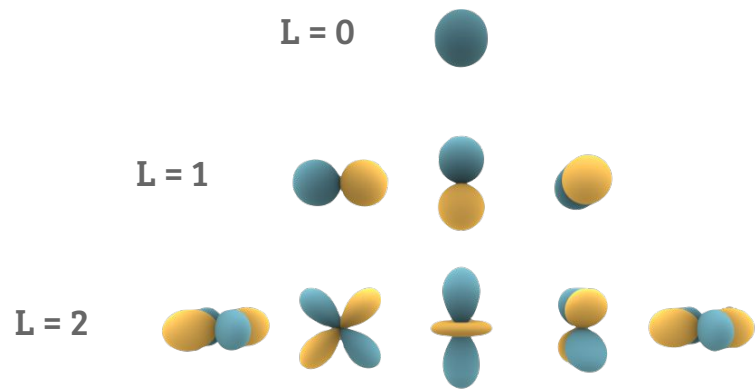
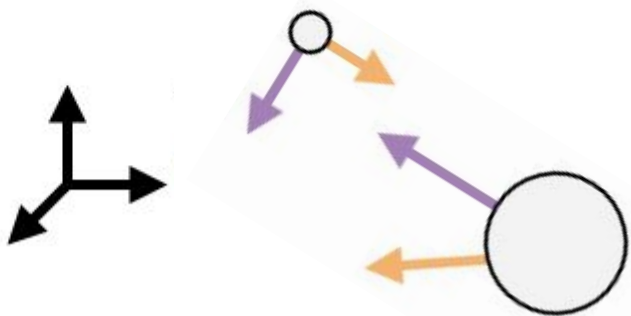

Irreducible representations

Scalars fields  $l = 0$

Vectors fields  $l = 1$

3x3 Matrix fields  $l = 0 \oplus 1 \oplus 2$

The input and output of our network is represented as tensors with **point** (or atom), **channel**, and **representation** indices organized by irreducible representation (L's and M's that index spherical harmonics).



**Representation** →

**Points** →

**Channels** →

Filters contribute a **representation** index due to use of spherical harmonics.

$$R(r) Y_l^m(\hat{r})$$

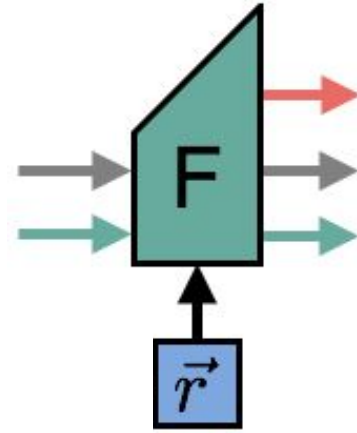

**Representation** 

**Points** 

**Channels** 

To combine two tensors to create one tensor, we use Clebsch-Gordan coefficients.

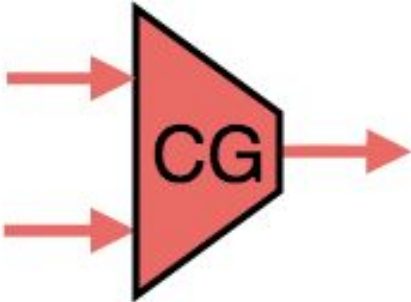

**Representation** →

**Points** →

**Channels** →

To combine two tensors to create one tensor, we use Clebsch-Gordan coefficients.

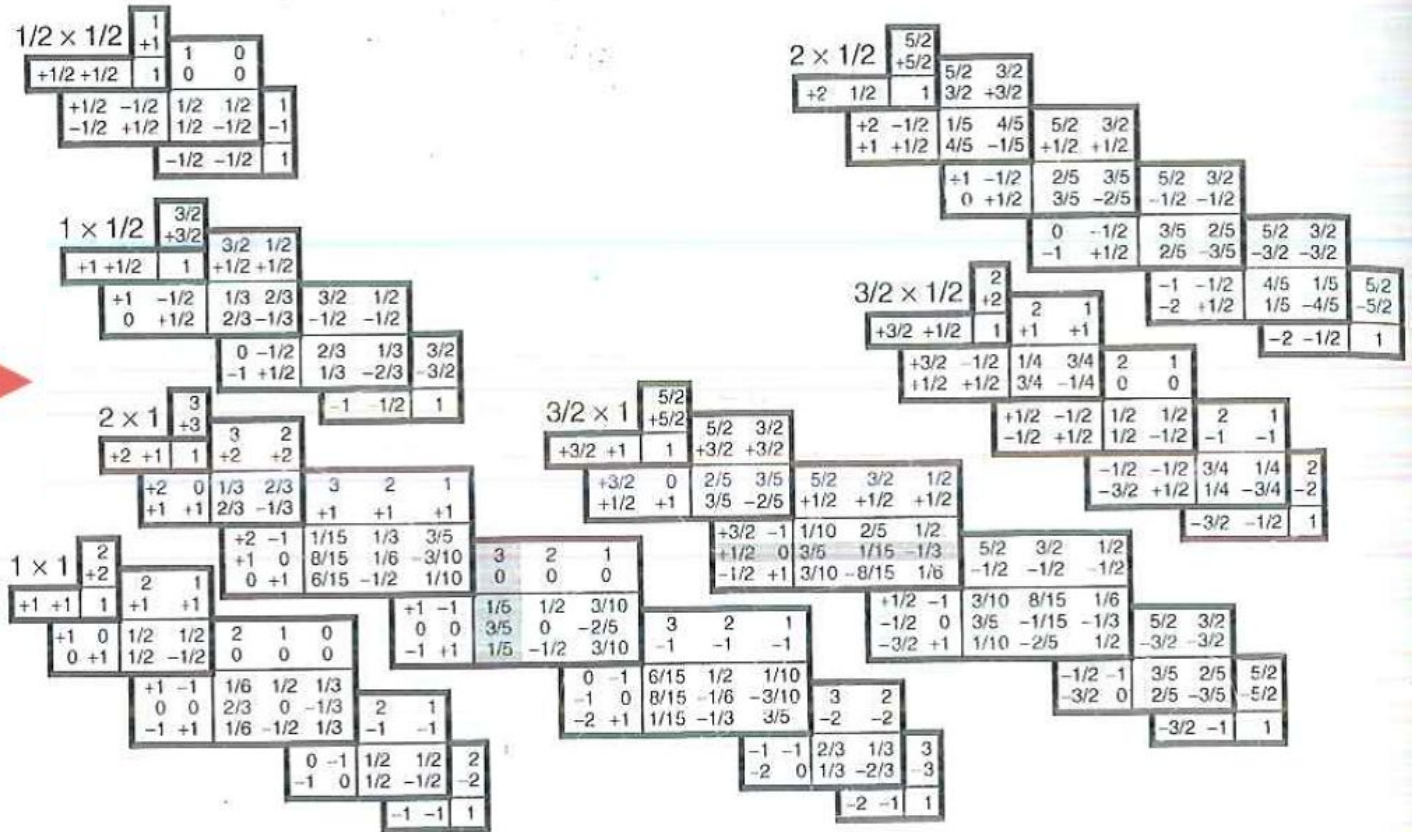
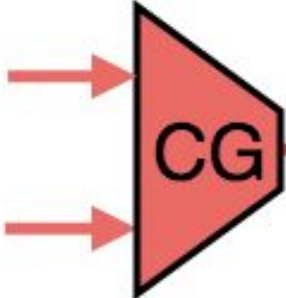

**We can start with tensor input of any type and use filters to get tensor output of any type.**  
 In this task, scalar masses are input and the moment of inertia tensor (a symmetric matrix) is output.

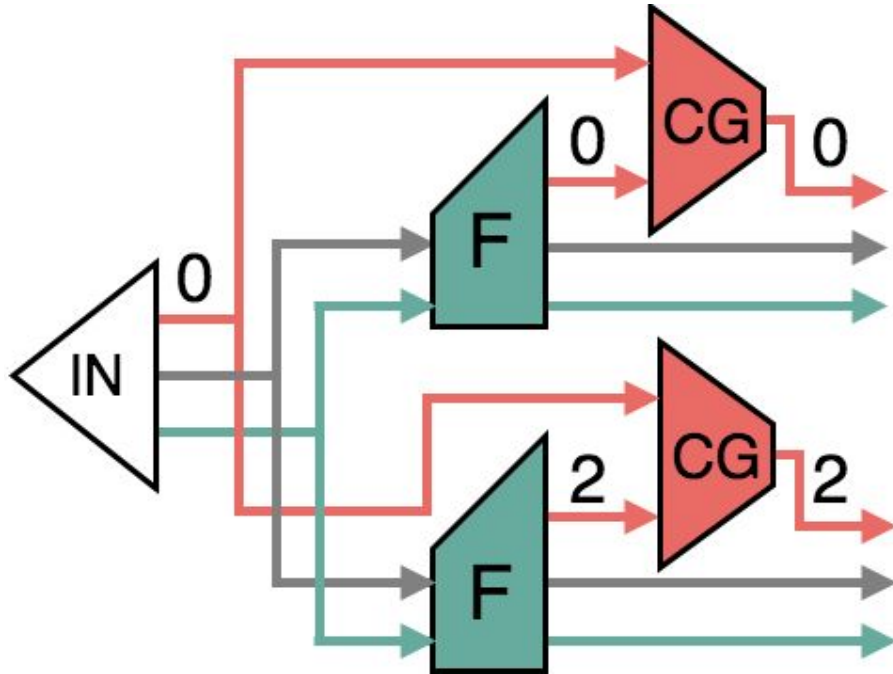

**Representation** →

**Points** →

**Channels** →

Moment of inertia:  
 0 (trace) + 2 (symmetric traceless)

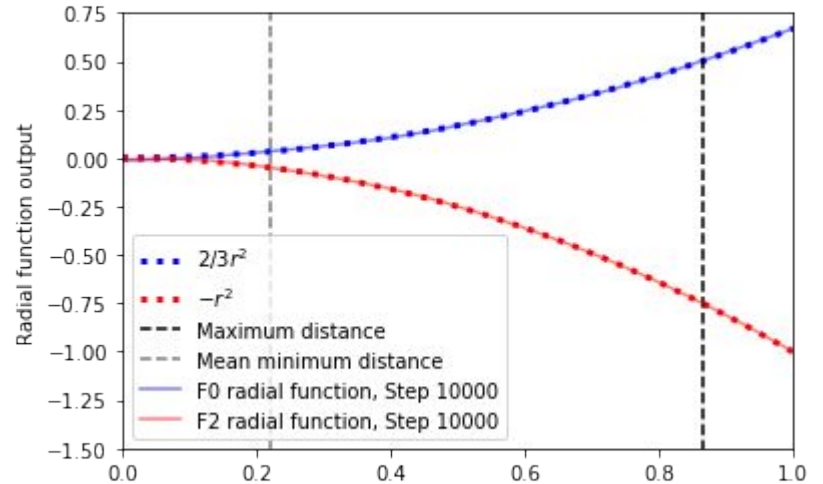

# These are components of **tensor field networks**

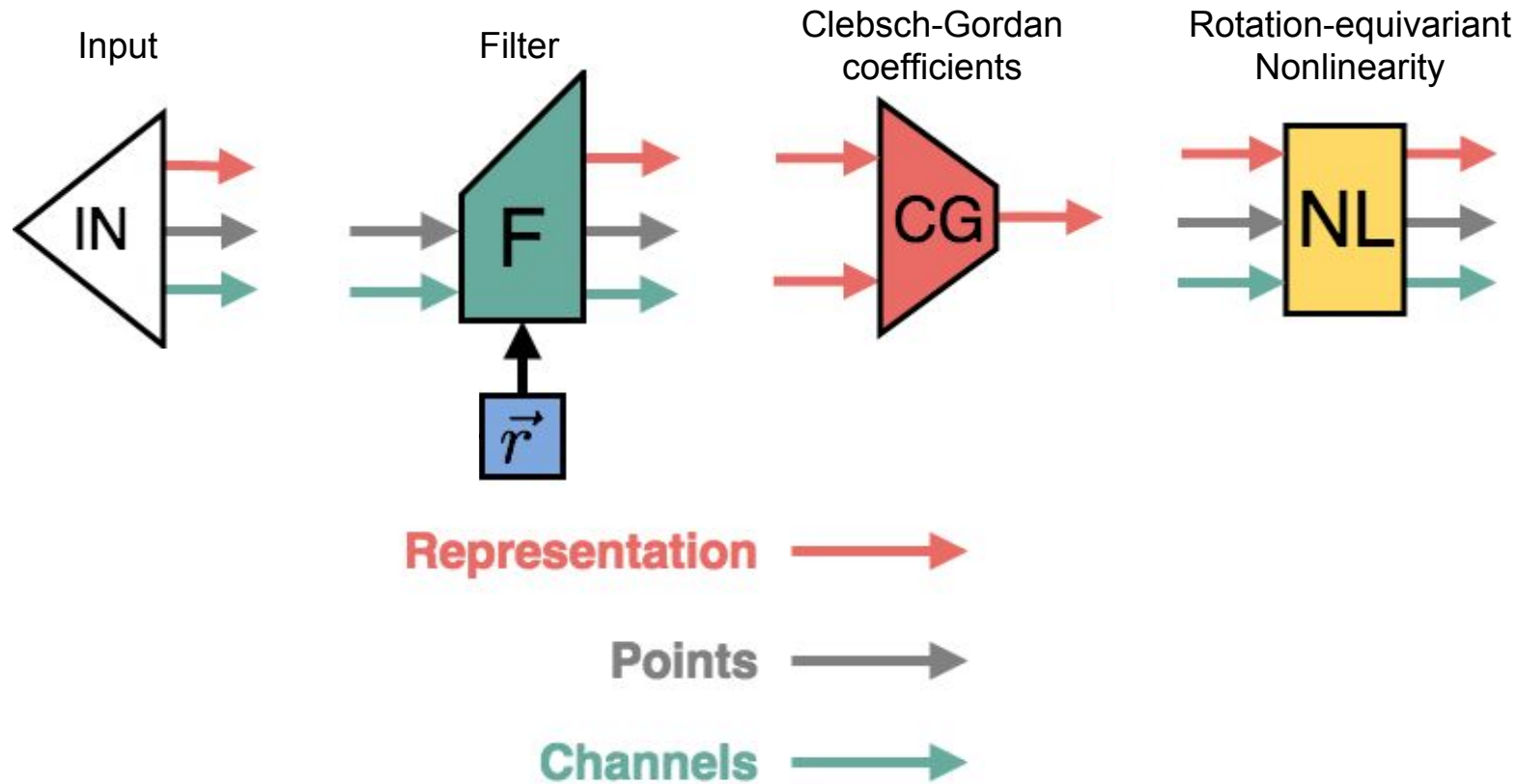

This is what a two-layer tensor field network looks like:

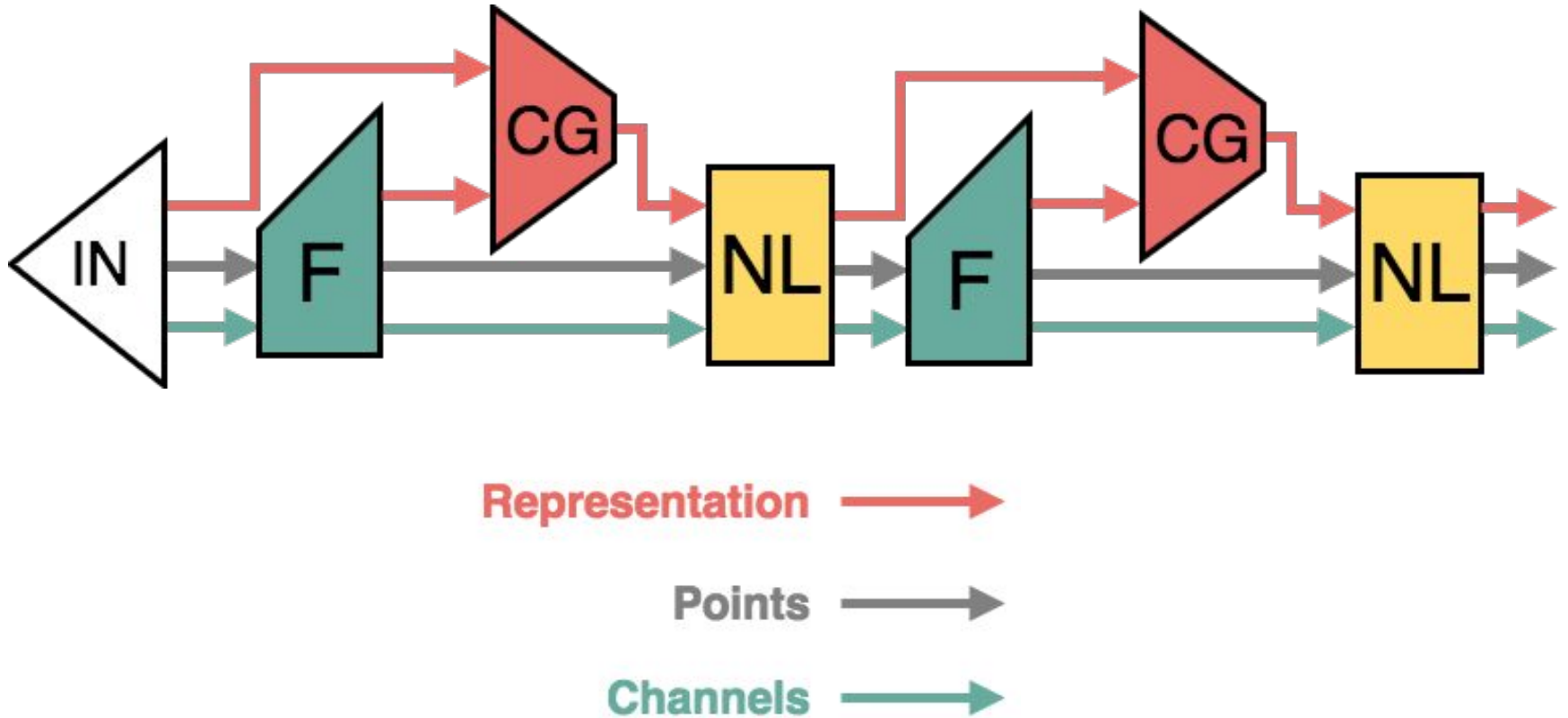



**We can start with tensor input of any type and use filters to get tensor output of any type.**  
In this task, scalar masses are input and gravitational acceleration vectors are output.

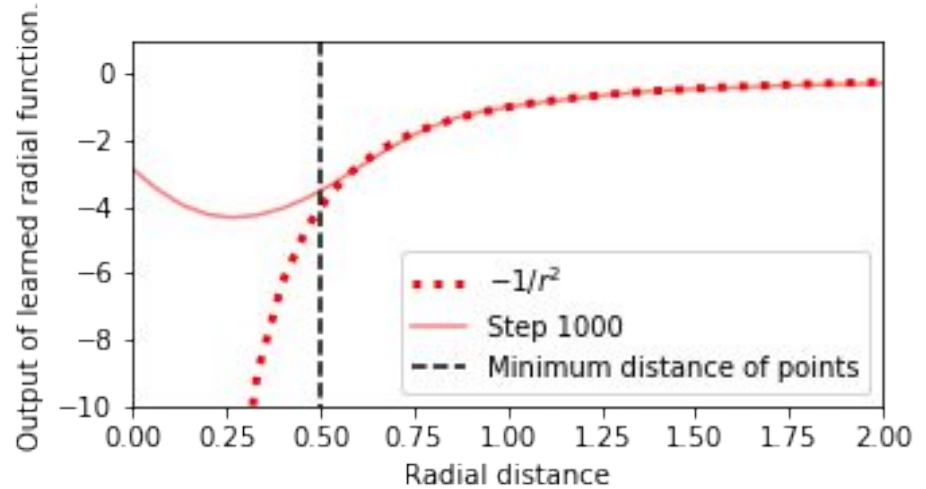
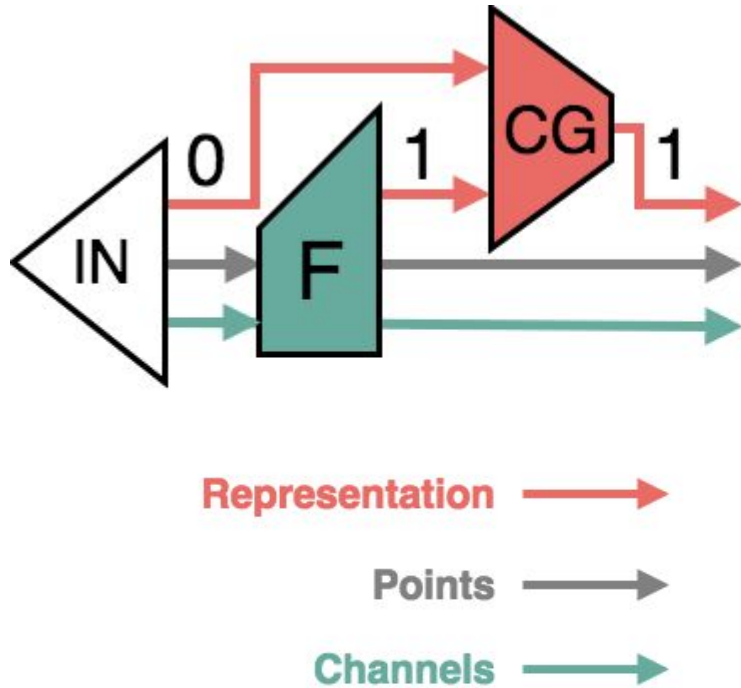

Given a small organic molecule with an atom removed, replace the correct element at the correct location in space.

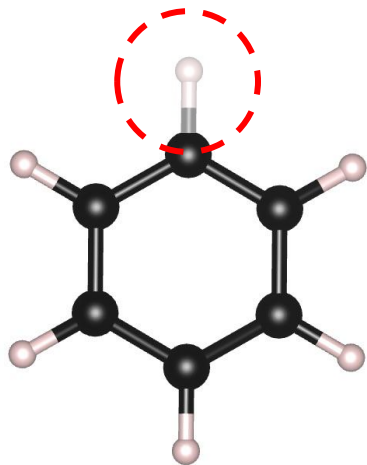

Input coordinates with missing atom.

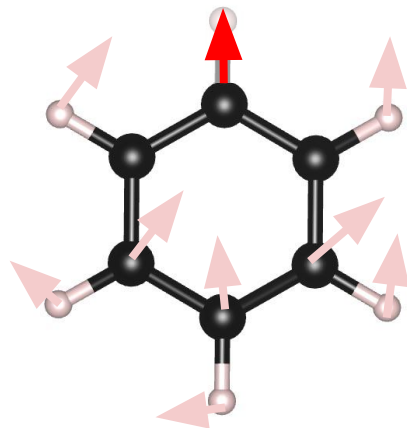

Network outputs  
(N-1) atom type features (scalars),  
(N-1) displacement vectors, and  
(N-1) scalars indicating confidence  
probability used for "voting".

#### DATASET

QM9: <http://www.quantum-machine.org/datasets/>  
134k molecules with 9 or less heavy atoms  
(non-hydrogen) and elements H, C, N, O, F.

#### TRAIN

1,000 molecules with 5-18 atoms

#### TEST

1,000 molecules with 19 atoms

1,000 molecules with 23 atoms

1,000 molecules with 25-29 atoms

Atoms	Number of predictions	Accuracy (%) ( $\leq 0.5 \text{ \AA}$ and atom type)	Distance MAE in $\text{\AA}$
5-18 (train)	15 947	92.6	0.16
19	19 000	94.7	0.15
23	23 000	96.9	0.14
25-29	25 404	97.8	0.17

Learns to replace atoms with over 90% accuracy across train and test by seeing the same 1,000 molecules 200 times.